



Arcom Communications
24035 NE Butteville Rd
Aurora, Oregon 97002
(503) 678-6182
arcom@ah6le.net

<http://www.ah6le.net/arcom/rc210/rc210.html>



RC-210 Repeater Controller

Operations and Programming Manual

Firmware version 4.21

April 8, 2004

Reproduction or translation of any part of this manual beyond that permitted by sections 107 or 108 of the 1976 United States Copyright Act (or its legal successor) without the express written permission of Arcom Communications is unlawful as noted below. Requests for permission to copy or for further information should be addressed to Arcom Communications. Except as noted above, permission is hereby granted for any non-profit group or individual to reproduce any portion of this document provided that: the reproduction is not sold for profit; the intent of reproduction is to further disseminate information on the RC-210 Repeater Controller kit; the reproduction is not used for advertising or otherwise promoting any specific commercial product other than the RC-210; and full credit is given to Arcom Communications as the original source of information.

The information contained in the manual has been carefully checked for accuracy and is believed to be entirely reliable. However, no responsibility is assumed for inaccuracies. Arcom Communications reserves the right to make changes in the RC-210 Repeater Controller kit to improve reliability, function or design without obligation to purchasers of previous equipment. Arcom Communications does not assume any liability arising out of the application or use of any product or circuit described herein; neither does it convey license under its patent rights or the rights of others.

(This page intentionally left blank)

COMMAND REFERENCE	6
Command Structure	6
Default Commands Accessible When Unlocked.....	7
Receiver Enable/Disable	7
Transmitter Enable/Disable.....	7
Carrier/CTCSS Access	7
TouchTone® Covertone.....	7
Courtesy Tone Selection.....	7
Kerchunk Filtering	7
Half/Full Duplex Operation	8
Port 3 For Control Receiver.....	8
Monitoring A Port from Other Ports.....	8
Linking Ports Quickly	9
Mix Monitored Audio with This Port RX Audio	9
Mute DTMF ON/OFF	9
Speech Override ON/OFF.....	9
Speech ID Override ON/OFF	9
Enable/Disable Port DTMF	9
Require/Not Require CTCSS for DTMF	10
Auxiliary Audio Inputs.....	10
General Logic Outputs	10
Extended Logic Outputs	10
Aborting ID's on DTMF	11
Remote Base Operation.....	11
Using the Doug Hall RBI-1 Remote Base Interface.....	12
Remote Base Power Select.....	12
Memory Select.....	12
Command Macros	13
Message Macros	13
ID Extras.....	13
Custom Command Prefix.....	13
Meter Alarms	14
Real Time Clock And Calendar.....	14
PROGRAMMING THE RC-210	15
General Programming Overview.....	15
Unlock Code Programming.....	15
Locking (leaving Program Mode)	16
Programming A Custom Lock Code	16
Programming A Custom Terminator Digit	16
A Word Of Caution Regarding The Terminator Digit.....	16
PORT UNIQUE VERSUS GLOBAL PROGRAMMING	17
Port Unique Programming.....	17
Timer Programming.....	17
Hang Time.....	17
Time Out Timer	17

Initial ID Timer	17
Pending ID Timer	17
Fan Timer	18
Port Inactivity Timer	18
DTMF Mute Timer	18
CTCSS Encode Dropout Timer	18
Alarm Timers	18
Auxiliary Audio Timers	19
Alarm Debounce Timer	19
Kerchunk Filter Timer	19
Pending ID Speech Timer	19
Periodic Message Timer	19
CTCSS Encode Control Line Polarity	19
Setting the Real Time Clock And Calendar	20
Year Readback	20
Adding A Correction Factor To The Real Time Clock	20
Remote Base Programming	21
Remote Base Prefix	21
Programming The RC-210 Command Macros	22
Command Macros	22
Using Command Macros To Remap Controller Functions	23
Command Macro Priority	23
Message Macros	24
Tail Messages	24
Some Practical Examples of Tail Message Programming	25
Speech Control Within Command Macros	26
List Of Port Direction Commands For Use In Macros	27
Controlling Command Macro Access By Port	27
Erasing All Command Macros	27
Erasing Command Macros	27
Startup Macro	27
Special Features	28
Temporarily Disabling ID's And Timeout Timer	28
DTMF Memories	28
DTMF Digits Duration and Time Between Digits	28
Macro Function Number List	29
Macro Function Number List (continued)	30
Macro Function Number List (continued)	31
The Scheduler	32
How Do We Define Setpoints?	32
Recurring Voice Messages	32
Plan! Plan! Plan!	33
Erasing SetPoints	34
Voice Message Editing And IDs	34
ID Extras	34
Enable/Disable Voice IDs	34
Using The Digital Voice Recorder (DVR)	35
Recording DVR Tracks	35
Playing A Recorded DVR Track	35

Erasing Tracks	35
Editing Recorded Tracks	35
Finding Out How Much Recording Time You Have Left	36
Auxiliary Audio Inputs.....	36
Resetting The RC-210.....	36
CW Speed Programming	37
CW Tone Programming.....	37
CW Message Programming.....	37
Courtesy Tone Programming	38
Courtesy Tone Behavior When Ports Are Linked.....	39
Programming Meter Faces - 10-bit A/D Converters.....	40
Programming Meter Alarms	41
A Practical Example.....	41
The Differences Between Accuracy And Precision.....	42
Programming the Reference Voltage Value for the A/D Converters.....	42
Measuring Voltages Higher Than Vref - A Practical Example.....	43
Alarm Programming.....	44
Using Auxiliary Audio Inputs With An Alarm	44
Using Auxiliary Audio Inputs With A Macro.....	44
Alarm Timers.....	44
Resetting The Unlock Codes.....	44
UPDATING THE FIRMWARE.....	45
Downloading And Installing The Required Software On Your Computer	45
Programming Cable	45
Downloading Firmware Updates	46
Configuring The Bascom Program For The First Time.....	46
Opening the Firmware Update.....	47
Loading the Firmware Into The RC-210.....	48
If You Are Running Windows® XP.....	49
Appendix A.....	50
Frequency Agile Radios Supported (Firmware Version 4.1).....	50
Factory Default Programming Values	50
Appendix B.....	51
CTCSS Codes.....	51
Appendix C.....	52
Default Factory Command Codes	52
Programming Commands Quick Reference	53
Vocabulary List.....	54
Audio Spectrum Analyzer Software.....	57
The RC-210 Development And Testing Team.....	57
ARCOM COMMUNICATIONS NO-NONSENSE LICENSE AGREEMENT FOR THE OPERATING FIRMWARE OF THE RC-210 REPEATER CONTROLLER.....	58

Command Reference

Command Structure

The RC-210 provides an extremely flexible and powerful command structure. Each port is capable of being controlled independently as well as controlling any other port.

There are 3 types of commands in the RC-210:

Port Specific commands that only affect one port.

Global commands which aren't port specific.

Programming commands that are used to program how the RC-210 operates.

Port Specific commands are specific to a particular port. For example, if you wanted to select a different courtesy tone on Port 1, you could do so without affecting the courtesy tone on the other ports.

Global commands are those which don't affect a specific port. A good example would be reading a meter face.

Programming commands are those which change the operating parameters of the RC-210. Some programming commands affect only a specific port. For example, programming the amount of hang time on Port 1. Other programming commands affect things that are not port specific. For example, entering a remote base frequency.

The controller evaluates and acts on entered DTMF digits under two conditions - upon COS closure of the receiver receiving the digits or upon receipt of the DTMF digit "D". For example, there is an interfering signal on the receiver you're currently using. Obviously the controller would never detect COS closure under this condition. By ending your entered command with a "D", you force the controller to act regardless of the COS state. This feature also permits you to string commands together, separated by a "D" and the controller will act on them one-at-a-time. This allows for automated programming, such as is done by our RCP Programming Software. Note: this terminator digit can be changed to be something other than "D". See the Programming section for details.

As it arrives from the factory, all commands in the RC-210 are protected behind the unlock commands. This means that no commands will be accepted by the RC-210 unless one of its 3 ports is first unlocked. Not to worry however, as you can easily assign any function in the RC-210 ("re-map") to be accessible without first unlocking the RC-210 (this is explained in the Macro section of this manual).

To some, this may seem a strange way to do things but there are distinct advantages to doing so:

- Most repeater system owners don't make the majority of functions available to general users.
- Since every RC-210 is shipped with the same default codes, you don't need to spend time reprogramming every, single command in order to prevent malicious users from "playing". Only those functions you specifically make available are accessible.
- You can assign your own custom code to every function as needed.

As you can see, this method gives you complete control over who will have access to which functions in your repeater system without compromising security on your system. And without you having to do a ton of work!

You may find it useful to familiarize yourself with how the various commands work and the controller response to each before you actually start custom programming your RC-210. You can do this by first unlocking the controller with one of the default lock codes, 15281.

While unlocked, the default values for the various command codes are listed in the next section, along with their description and syntax. An asterisk next to each description signifies the default power up state of that function (this can be changed by programming).

You may also define a custom *Command Prefix* that must be used with all default commands. This can prevent code conflicts when you use your RC-210 with another system that also uses DTMF commands, for example IRLP© or EchoLink©.

Default Commands Accessible When Unlocked

Receiver Enable/Disable

Each port's receiver may be temporarily disabled individually to prevent a signal from that receiver from being recognized. Note that this setting is not stored in non-volatile memory and upon a controller reset or power up, all receivers will once again be enabled.

1101 Port 1 Receiver Enable*	2101 Port 2 Receiver Enable*	3101 Port 3 Receiver Enable*
1100 Port 1 Receiver Disable	2100 Port 2 Receiver Disable	3100 Port 3 Receiver Disable

Transmitter Enable/Disable

Each port's transmitter may be disabled individually to prevent keying by itself or other ports. This command completely disables the transmitter on that port, except for ID's

1111 Port 1 Enable*	2111 Port 2 Enable*	3111 Port 3 Enable*
1110 Port 1 Disable	2110 Port 2 Disable	3110 Port 3 Disable

Carrier/CTCSS Access

Each port supports an external CTCSS (or digital) decoder, the action of which may be controlled with these commands.

1121 Port 1 CTCSS	2121 Port 2 CTCSS *	3121 Port 3 CTCSS
1120 Port 1 Carrier*	2120 Port 2 Carrier*	3120 Port 3 Carrier*

TouchTone® Covertone

Whenever a DTMF digit is pressed, the receiver audio from that port is muted. Optionally, a covertone may be selected so users aren't faced with "dead air".

1131 Port 1 Touchtone® Covertone ON*	2131 Port 2 Touchtone® Covertone ON*	3131 Port 3 Touchtone® Covertone ON*
1130 Port 1 Touchtone® Covertone OFF	2130 Port 2 Touchtone® Covertone OFF	3130 Port 3 Touchtone® Covertone OFF

Courtesy Tone Selection

Each port has 10 programmable courtesy tone sets.

1134x Port 1 Courtesy Tone Select x = 1-10 (1*)	2134x Port 2 Courtesy Tone Select x = 1-10 (1*)	3134x Port 3 Courtesy Tone Select x = 1-10 (1*)
---	---	---

Kerchunk Filtering

Each port has its own filtering command to prevent users from "kerchunking" that port. When turned on, these filters require that users key up for a period of at least the setting of the Kerchunk Timer before the RC-210 will recognize it as a valid signal.

1151 Port 1 Kerchunk Filter On	2151 Port 2 Kerchunk Filter On	3151 Port 3 Kerchunk Filter On
1150 Port 1 Kerchunk Filter Off*	2150 Port 2 Kerchunk Filter Off*	3150 Port 3 Kerchunk Filter Off*

Half/Full Duplex Operation

Each port may be defined as full duplex, where a signal on that port's receiver is retransmitted out that port's transmitter. Or it may be defined as half duplex, where a signal on that port's receiver is NOT retransmitted out that port's transmitter. For example, if you wanted to use Port 2 for a half-duplex/simplex remote base, you would not want its transmitter to be activated by its receiver. You would therefore define that port as being half duplex. Of course if you want to use a particular port (or all ports) for a repeater, that port needs to be defined as full-duplex.

1141 Port 1 Full Duplex* **2141** Port 2 Full Duplex **3141** Port 3 Full Duplex
1140 Port 1 Half Duplex **2140** Port 2 Half Duplex* **3140** Port 3 Half Duplex*

Port 3 For Control Receiver

Port 3 may be designated as the *Control Port*. The *Control Port* is very special, as it is possible to take complete control of the controller and override the operation of the other ports.

Some owners like to monitor activity on their repeater(s) without actually revealing their presence but be able to take control immediately should the situation warrant. This is easily accomplished by using Port 3 as your *Control Port*. By using a dedicated (and not announced to the general public) half or full-duplex radio on Port 3, the Port to Port connect commands allow monitoring of the other ports. Activity on the other ports continues normally and you may enter DTMF commands normally in this condition, as may the other ports. **Note: Port 3 must be defined as full-duplex in order to monitor other ports in this manner**

If you need to take control, use the Control Port Override ON command and activity on the Control Port receiver will lock out the other ports' DTMF decoders, mute the audio from the other ports and replace their audio with Port 3's audio. This gives you total control of your repeater. When you are done, you simply turn the Override off.

2501 Control Receiver Override ON
2500 Control Receiver OFF*

Monitoring A Port from Other Ports

Any port may be selectively monitored by any other port. In the RC-210, with multiple monitor commands you can create any combination of monitoring from port to port. This provides considerable flexibility in audio routing. Each of these monitoring commands is a **one-way** connection. In other words, if you select to monitor Port 2 from Port 1, activity on Port 1 will not be retransmitted on Port 2.

To create a two-way path between ports, you have two choices. You can either establish 2, one-way connections between ports or you could use the Linking Commands (this is explained below).

Assume a user on Port 1 wants to monitor activity on Port 2. The user enters command **1301** and a one-way connection is established, allowing the monitoring **of** Port 2 **by** Port 1. Now, activity on Port 2 is retransmitted out Port 1, but Port 1 is not retransmitted out Port 2. It doesn't matter what port is used to issue these commands.

PORT 1	PORT 2	PORT 3
1301 Monitor Port 2 ON 1300 Monitor Port 2 OFF*	2301 Monitor Port 1 ON 2300 Monitor Port 1 OFF*	3301 Monitor Port 1 ON 3300 Monitor Port 1 OFF*
1311 Monitor Port 3 ON 1310 Monitor Port 3 OFF*	2311 Monitor Port 3 ON 2310 Monitor Port 3 OFF*	3311 Monitor Port 2 ON 3310 Monitor Port 2 OFF*

After monitoring for a while, the user decides that they want to join in the conversation. By issuing the command **2301**, activity on Port 1 is now retransmitted out Port 2. In other words, there is now a two-way connection between Ports 1 & 2.

A two-way connection made in the above manner can be taken down by first turning off monitoring from the port you are on from being monitored by the other port. Then stop monitoring that other port with a second command. For example, if you have a two-way monitor between Ports 1 and 2, and you are actively using Port 1, send the command **2300** first so Port 1 activity does not appear on Port 2, then send **1300** to stop monitoring Port 2. It can be taken down the other way, but if there is an interruption you will be transmitting Port 1 audio on Port 2 and not realize when Port 2 is busy.

Linking Ports Quickly

You may also establish two-way connections (linking) between ports quickly and easily by using only one command. Likewise, you can also disconnect (unlink) ports using these commands. **Note: Even if you established port monitoring using the Monitor Commands above, you may use the Linking Commands to turn them off or modify them. In other words, the Linking Commands take precedence over Monitoring commands.**

A11	Link Port 1 to Port 2	A10	Unlink Port 1 from Port 2*
A21	Link Port 1 to Port 3	A20	Unlink Port 1 from Port 3*
A31	Link Port 2 to Port 3	A30	Unlink Port 2 from Port 3*
A41	Link all ports to all other ports	A40	Unlink all ports from all other ports*

Mix Monitored Audio with This Port RX Audio

This function selects whether audio from the monitored port(s) is mixed with the audio from the monitoring port or muted when there is activity on the monitoring port.

PORT 1	PORT 2	PORT 3
1191 Monitor Mix*	2191 Monitor Mix*	3191 Monitor Mix*
1190 Monitor Mute	2190 Monitor Mute	3190 Monitor Mute

Mute DTMF ON/OFF

This command selects whether DTMF digits received on the selected port are retransmitted or muted.

PORT 1	PORT 2	PORT 3
1211 Mute DTMF ON*	2211 Mute DTMF ON*	3211 Mute DTMF ON*
1210 Mute DTMF OFF	2210 Mute DTMF OFF	3210 Mute DTMF OFF

Speech Override ON/OFF

Setting the Override to OFF causes user audio to be mixed with non-ID Speech. Setting the Override to ON causes non-ID speech to be stopped if a signal appears on that port's receiver.

PORT 1	PORT 2	PORT 3
1201 Speech Override ON	2201 Speech Override ON	3201 Speech Override ON
1200 Speech Override OFF*	2200 Speech Override OFF*	3200 Speech Override OFF*

Speech ID Override ON/OFF

Setting the Override to OFF causes user audio to be mixed with ID Speech. Setting the Override to ON causes ID speech to be stopped if a signal appears on that port's receiver, in which case the voice ID reverts to CW in order to ensure the repeater is properly identified.

PORT 1	PORT 2	PORT 3
1181 Speech ID Override ON	2181 Speech ID Override ON	3181 Speech ID Override ON
1180 Speech ID Override OFF	2180 Speech ID Override OFF	3180 Speech ID Override OFF

Enable/Disable Port DTMF

Each port may have its DTMF decoder disabled. This function is useful under several circumstances, such as when a user is causing problems. As a precaution, it is not possible to disable DTMF on the port to which you're currently connected. For example, you must be using a radio (or repeater) connected to Port 2 or 3 in order to disable DTMF on Port 1.

1161 Port 1 DTMF Enable*	2161 Port 2 DTMF Enable*	3161 Port 3 DTMF Enable*
1160 Port 1 DTMF Disable	2160 Port 2 DTMF Disable	3160 Port 3 DTMF Disable

Require/Not Require CTCSS for DTMF

Each port may be configured to either require a user's signal to contain CTCSS or not require it, in order to enter DTMF commands. This selection controls DTMF access regardless of the state of the access required for repeater access on that port. In other words, it is possible to have a port configured for carrier squelch access, yet require CTCSS for DTMF commands to work.

1170	Port 1 no CTCSS for DTMF*	2170	Port 2 no CTCSS for DTMF*	3170	Port 3 no CTCSS for DTMF*
1171	Port 1 CTCSS for DTMF	2171	Port 2 CTCSS for DTMF	3171	Port 3 CTCSS for DTMF

Auxiliary Audio Inputs

These inputs can be used for connecting external audio devices, such as a weather receiver. When turned on, the selected transmitter is locked on for a period selected by a programmable timer. After this timer times out, the audio is disconnected and the transmitter is unkeyed. Which port a particular input is routed to is determined by programming commands.

1961	Turn Auxiliary Audio Input 1 ON	1981	Turn Auxiliary Audio Input 3 ON
1960	Turn Auxiliary Audio Input 1 OFF	1980	Turn Auxiliary Audio Input 3 OFF
1971	Turn Auxiliary Audio Input 2 ON		
1970	Turn Auxiliary Audio Input 2 OFF		

General Logic Outputs

There are 7 switched outputs that can be commanded on or off. They can also be pulsed (0.1 ms low, 0.1 ms open, 0.1 ms low). When an output is high, it is actually an open collector. If you need a logic high present, you can provide a pull up resistor (up to 100 vdc).

1810	Logic Output 1 Open Collector	1850	Logic Output 5 Open Collector
1811	Logic Output 1 Low	1851	Logic Output 5 Low
1812	Logic Output 1 Pulsed (low, open, low)	1852	Logic Output 5 Pulsed (low, open, low)
1820	Logic Output 2 Open Collector	1860	Logic Output 6 Open Collector
1821	Logic Output 2 Low	1861	Logic Output 6 Low
1822	Logic Output 2 Pulsed (low, open, low)	1862	Logic Output 6 Pulsed (low, open, low)
1830	Logic Output 3 Open Collector	1870	Logic Output 7 Open Collector
1831	Logic Output 3 Low	1871	Logic Output 7 Low
1832	Logic Output 3 Pulsed (low, open, low)	1872	Logic Output 7 Pulsed (low, open, low)
1840	Logic Output 4 Open Collector		
1841	Logic Output 4 Low		
1842	Logic Output 4 Pulsed (low, open, low)		

Note: These outputs are independent of the "Output Sinkers" functions provided by the Doug Hall RBI-1 Remote Base Interface, which work in addition to the Logic Outputs above. See the Remote Base section of this manual for details.

Extended Logic Outputs

If you have connected external shift registers as explained in the Hardware Reference section of this manual, you have a total of 64 logic outputs available to you.

1810	Logic Output xx (1-64) to state y
y = 0	Logic low
y = 1	Logic High
y = 2	Pulsed output (low, open, low)

Alarms

Each Alarm may be individually turned ON or OFF. While ON, if an alarm is triggered, it will either call a macro every 30 seconds, connect one of the Auxiliary Audio Inputs to the port of your choice or call a macro. This continues until the Alarm TimeOut period occurs or until that Alarm is turned off (disabled). See the Programming Reference section for details about programming the Alarms.

1901	Alarm 1 Enabled	1941	Alarm 4 Enabled
1910	Alarm 1 Disabled	1940	Alarm 4 Disabled
1921	Alarm 2 Enabled	1951	Alarm 5 Enabled
1920	Alarm 2 Disabled	1950	Alarm 5 Disabled
1931	Alarm 3 Enabled		
1930	Alarm 3 Disabled		

Aborting ID's on DTMF

When entering a long string of commands (such as when using the Arcom RCP Programming Software), the controller may try to force an ID in the middle of the sequence. This may cause some commands to be lost. By enabling this function, if there is DTMF activity during an ID (either voice or cw), that ID will be immediately stopped until after the current command that is waiting in the command buffer, is processed. The scheduled ID will then run in its entirety. You may also wish to turn this function off at time, especially if some user delights in sending DTMF in order to interrupt the ID.

*2400	ID Abort ON
*2401	ID Abort OFF

Remote Base Operation

Any of the 3 ports may be used to connect a remote base radio. See Appendix A for a list of supported radios.

The type radio you plan to use with the RC-210 is selected by programming commands. Because of the different formats used with radios within the Yaesu line, you must also select which model you wish to use. See the Programming Reference section of this manual for details. **The default Remote Prefix is "A7", so you must preface each of the Remote Base codes below with it.**

The commands to control the radio are:

A71xxx.xxx y Enter Frequency with transmit offset*.
Frequency entered must be padded with zeros to make it 6 digits long.

Examples:

A 7 1 1 4 6 6 4 0 3 = 146.640 plus offset
A 7 1 4 4 8 3 2 5 1 = 448.325 minus offset
A 7 1 0 1 4 1 9 5 2 = 14.195 no offset
A 7 1 0 0 7 1 5 0 2 = 7.150 no offset

*Note: the offset must always be entered, even if
if you are not in FM mode.*

*The last digit represents the repeater offset .
y equals
1 - minus
2 - simplex
3 - plus

A72xy Enter CTCSS code and select encode and/or decode. The 2 digit code used for a particular frequency is shown in Appendix B. Y =:
1 = Encode only
2 = Encode/Decode

Examples:
A 7 2 1 2 1 = 100.0 Hz encode only
A 7 2 1 9 2 = 127.3 Hz encode/decode
A 7 2 0 0 2 = CTCSS off

*Note: To turn off CTCSS, enter "00" for the frequency code
and 2*

A73x Mode select. x equals: *Note: This command only has relevance if you're using a remote base radio capable of multimode use.*
1 = LSB
2 = USB
3 = CW
4 = FM
5 = AM

Note: Any port used for a remote base should be defined as half-duplex.

A75x Recall Remote Base Memories 1 to 10 (this command only affects NON-DOUG HALL supported radios)

Using the Doug Hall RBI-1 Remote Base Interface

There are extra remote base commands available for use if you have selected the Doug Hall RBI-1 for use as your remote base. **Note: these only work if "5" is selected as your remote base radio type**

User Function Outputs

The RBI-1 provides 7 *User Function* outputs that can be used (in addition to Logic Outputs of the RC-210) to control hardware at the repeater site. Refer to the Doug Hall manual for details on making connections.

A74 x y User Outputs 1 through 7, where "x" is the output and "y" = 1 ON, 2 OFF

Remote Base Power Select

A75 x Select Transmitter power of the connect remote base radio, where x
0 Low Power
1 High Power
2 Medium Power
3 Don't change

Memory Select

The Doug Hall RBI-1 provides for memory recall of up to 20 memories within the controlled radio

A76x Select Memory 1 - 20

Command Macros

In the RC-210, Command Macros serve several purposes:

- To execute many different functions with one single command. This allows the owner to program multiple controller functions to take place by the entering of only one command.
- To generate and direct speech messages. These are generally used for such things as Good Morning/Afternoon/Evening messages that the scheduler uses.
- To remap controller functions so they'll be available without having to first unlock the controller. By default, the RC-210 will not accept commands unless one of the 3 ports is first unlocked. By remapping controller functions in a macro, these functions are made available without having to first unlock a port. This is how you provide commands for your general users.

There are 2 types of Command Macros - "Long" and "Short":

- Command Macros 1 to 40 can store up to 15 functions each
- Command Macros 41 to 90 can store up to 4 functions each

Typically, Command Macros 41 to 90 are used to remap functions and you can include up to 4 functions in a single one of these macros. Remember however that there is nothing preventing you from using ANY Command Macro you like to accomplish this, but most RC-210 will probably want to reserve the Long Macros for those things where many functions are to be done with a single command. The RC-210 gives you this kind of flexibility and the choice of which type of Command Macro to use is totally up to you.

Some things you need to remember when programming Command Macros:

- A Command Macro may call any other Command Macro, regardless of whether it's a Long or Short macro
- Any Macro Command Function that is numbered higher than 255 requires two slots, while those lower than 254 only require one. That is to say that you can only fit two functions with a number higher than 254 into a Short Macro.

Each macro may be assigned its own unique command code, so you can define one of your own choosing. See the Programming Reference section of the manual on how to program both the macro codes, as well as the macros themselves.

Macros may also be called from the Scheduler and the Alarms to automate commands. See the Scheduler and Alarm sections in the Programming section of this manual for details.

Message Macros

There are 40 Message Macros, each of which is capable of storing up to 10 words (or DVR tracks) of speech and can be used with any command. See the Programming section for details.

ID Extras

ID Extras allow you to add various "phrases" to the Voice ID Messages. These ID Extras allow you to include such messages as "Good Morning/Afternoon/Evening (automatically selected by the controller for the appropriate time of day), the time of day or date before OR after the actual ID. See the Programming section of this manual for details.

Custom Command Prefix

When you use your RC-210 with an external system that also uses DTMF codes, you may find there are conflicts between the default factory commands and the external system. For example, IRLP© uses 4 digit commands and it may try to interpret commands destined for the RC-210 and give an error. To avoid this, you may program up to a 6 digit *Command Prefix*, which must then be used ahead of all RC-210 non-programming command **but only when the RC-210 is unlocked.** The Command Prefix has no effect on any Command Macros you use to reassign functions.

***2104x** Up to a six digit sequence. Programming a "0" as the only digit will erase the Command Prefix

Analog Meter Inputs

Analog measurement capability consists of an 8 channel 10 bit analog to digital converter capable of measuring 8 input voltages between 0 and a voltage called "Vref." Signals may be provided from the receiver s meter and deviation metering circuits, from wattmeters, temperature sensors and other transducers. There are a number of meter face names you can use, including Volts, Amps, Watts, Degrees, Miles per Hour, and Percent. Scaling of these meter faces is completely programmable by the owner.

The voltage from an external sensor is applied to the Analog to Digital (A/D) input, it is measured, and based on the way you setup the meter reference levels, it "Speaks" the measured value. Sensor voltages must be between 0 vdc and Vref, a maximum value that can either be the internal reference level of 2.56 vdc (generated on the CPU itself) or an "external" value (External to the processor) provided by the 5 volt regulator on the RC210. The setting of Vref is one of the issues involved in using the Meter Inputs. When a meter readback command is entered, the controller reads back a value that represents the average of several measurements. The A/D measurements are being taken every second and smoothed in the controller firmware to provide a stable reading.

Using the A/D or ADC (same thing) adds the ability to keep track of battery voltage, temperature, wind speed, repeater transmit power, etc. Also, high and low values are stored and can be read back by the user. Also, meter Highs and Lows can be reset using a command for each meter, or a global command to clear all the meter highs and lows with one command.

How to setup Meters, to calibrate them and use them is explained later in the Programming section of this manual

1400 (channel 1 - 8) Readback current value

Meter Alarms

Each of the Analog Meter Inputs has programmable high and low alarms which when tripped will run a Command Macro. See the Programming section of this manual for details.

Each of the 8 Meter Alarms may be enabled, suspended or have their High/Low values cleared:

To reset a meter's High/Low Stored value:

1500x where "x" is the Meter channel you wish to clear

- x 0 - Clear All Channels
- x 1 - Clear Channel 1
- x 2 - Clear Channel 2
- x 3 - Clear Channel 3
- x 4 - Clear Channel 4
- x 5 - Clear Channel 5
- x 6 - Clear Channel 6
- x 7 - Clear Channel 7
- x 8 - Clear Channel 8

To enable or suspend a meter alarm:

1600xy where x = 1 to 8 for the meter channel and y = 1 for ON and 4 = suspend.

Suspending a meter alarm retains that alarm's programming but causes it to ignore being tripped.

Real Time Clock And Calendar

If the Real Time Clock has been set since the last power outage, this command will announce the current time.

1700 Announce current time

Note: If the Real Time Clock has not been set since the past power outage, the controller will say "Clock Not Set".

If the calendar has been set since the last power outage, this command will announce the current date

1701 Announce current date

Note: If the Calendar has not been set since the past power outage, the controller will say "Date Not Set".

Programming The RC-210

General Programming Overview

Each port on the RC-210 is programmed individually and the programming for one does not affect the others. The programming commands for each port are identical - the only difference being the port you've "unlocked" to program. This makes it easier to remember the code for programming a particular command/function.

For example, the code to program the Initial ID Timer is *1002, regardless which port you wish to program. What differentiates which port is being programmed is determined by which port you unlocked through the use of its unlock code.

While you are in programming mode you can re-enter an Unlock code at any time to unlock a different port without having to lock the controller first. For example, if the controller's Port 1 is already unlocked, you can simply enter Port 2's unlock code and change over to programming Port 2.

While unlocked, you may also play back your ID messages, based on which port is currently unlocked. This allows for easy verification of your ID messages as you program them.

AA1	The currently unlocked port CWID # 1
AA2	The currently unlocked port CWID # 2
AA3	The currently unlocked port Voice ID # 1
AA4	The currently unlocked port Voice ID # 2
AA5	The currently unlocked port Voice ID # 3

As mentioned in the Command Reference section of this manual while any port is unlocked, you can use any of the default command codes.

In addition, by prefacing any Macro Command with "*" *", you can recall any previously programmed Macro.

Unlock Code Programming

The RC-210 comes programmed with a default unlock codes for each port. To unlock any port for the first time, enter the default code.

15281	Port 1 default unlock code
25281	Port 2 default unlock code
35281	Port 3 default unlock code.

For example, to unlock Port 1 for the first time, enter 1 5 2 8 1 and unkey. The controller will respond with "ULP1", indicating that Port 1 is now unlocked and ready to accept programming. The code to reprogram the unlock code is * 9 0 0 0 followed by up to 8 digits - those digits will become your new unlock code for that port.

Note: For security reasons, you should try and use all 8 digits for the unlock codes.

For example, you want to program the unlock code for Port 1 to "**22334455**". Key your radio and enter * **9 0 0 0 2 2 3 3 4 4 5 5** and unkey. The controller should respond with "CODE". Your new code is now set and will stay set until you explicitly change it, even through power off cycles. It is suggested the first thing you do is reprogram the unlock code for each port.

Some owners prefer to use a prefix, followed by a command unlock code. This makes it even easier to remember the codes. For example, you could program Port 1 unlock code as **12463683** , Port 2 as **22463683** and Port 3 as **32463683**. Of course this is strictly up to you, but the flexibility of the RC-210 allows you this sort of freedom.

Important: Write your unlock codes down and keep them in a safe place. Should you lose them, it is possible to reset them back to factory defaults. See "Resetting your unlock codes" on Page 41 for details on how to do this.

Locking (leaving Program Mode)

To lock the controller when you're done programming, you use a (by default) single "#". The controller will respond with "LOCK", confirming you are no longer in program mode. Also, when any port is unlocked, a timer is started. Should no valid DTMF digit be received at least every 2 minutes, the controller will automatically lock itself and announce that fact.

Programming A Custom Lock Code

Perhaps # conflicts with your intended code scheme, so the RC-210 allows you to reprogram the Lock Code to be up to 4 digits long. **This code is not unique to any port and will be used to lock the controller regardless of which port is unlocked at the time.**

***9010xxxx** where "xxxx" is your new Lock Code of any length from 1 to 4 digits.

Programming A Custom Terminator Digit

By default, the RC-210 recognizes a "D" as its terminator digit, forcing any DTMF digits beforehand to be evaluated by the command decoder. Under some circumstances, "D" may conflict with a code used for some other function. If necessary, you can reprogram the terminator digit to be any other single DTMF digit.

***9020x** where "x" is the single DTMF digit that will cause the RC-210 to evaluate DTMF digits preceding it.

A Word Of Caution Regarding The Terminator Digit

Should you decide to change the Terminator Digit from its default value, remember that you can no longer use that new digit anywhere in any command. For example, it would be a bad idea to use "1" as your Terminator Digit, as you would not be able to use "1" in any other command, as well as losing access to the defaults commands that have a "1" in their code.

Generally speaking, if you wish to redefine the Terminator Digit, you should strive to use one of the less commonly used DTMF digits, such as *, #, A, B or C.

Port Unique Versus Global Programming

There are two types of programming commands:

Those that affect only the port you currently have unlocked. These are referred to as *Port Unique Programming Commands*, which may be done from any radio port. In other words, you can program Port 2 while actually using a radio connected to Port 1.

Those commands which are shared between all ports or don't apply to a specific port. These are referred to as *Global commands*. For example, reading an ADC channel or controlling a remote base radio.

Port Unique Programming

Timer Programming

Unless otherwise noted, all of the following commands may be programmed with only those digits necessary. In other words, if the value you wish to enter is "20", you need only enter "20". If you want to enter "1234", you simply enter "1234" for that programming command.

Hang Time

Each port has its own programmable hang time when that port is configured for full-duplex operation (in half-duplex, there is no hang time).

***1000x** where "x" is the amount of hang time for that port's transmitter in seconds. The range is 1 to 255 seconds. The controller responds with "HANG TIMER SET".

Time Out Timer

Each port is provided with a time out timer that will drop the transmitter should a signal appear on it's receiver input for longer than the programmed time out period (this only applies if that port is in full-duplex).

***1001x** where "x" is the time out period for that port's transmitter in seconds. The range is 1 to 32767. The controller responds with "TIMEOUT SET". **Note: Programming the timer to zero disables it.**

Initial ID Timer

This timer sets the amount of time the repeater must be idle before sending the Initial ID. For example, if you set this timer to 10 minutes and that port is in full-duplex and unused for at least 10 minutes, this ID will play upon initial keyup. It won't play again until the repeater sits idle for another 10 minutes.

***1002x** where "x" is the amount of time in minutes between ID's. The default time is 10 minutes and there is really no need to change it, but it can be changed from 1 to 255 minutes. The controller responds with "IID TIMER SET".

Pending ID Timer

After the initial ID is sent, the Pending ID timer is started. While this timer is running, if during this time there is activity on that port, the Pending ID message will be sent. If activity continues, the Pending ID will be sent every period, programmed by its timer. If there is no activity after the initial keyup, no further IDs are sent until the Initial ID period has elapsed. Also see the Pending ID Speech Timer below for more information on how this works.

***1003x** where "x" is the amount of time in minutes the Pending ID waits after an Initial ID occurs. The default is 10 minutes and there is really no need to change it, but it can be changed from 1 to 255 minutes. The controller responds with "PID TIMER SET".

Fan Timer

The RC-210 provides a convenient method of controlling a cooling fan, while eliminating unnecessary wear and tear. When any Port is keyed, the fan is started and will remain on for a period determined by the Fan Timer. It will then automatically shut off.

***1004x** where "x" is the amount of time you want the fan to remain on after any transmitter unkeys in seconds. The range is 1 to 32767 seconds. The controller responds with "FAN TIMER SET".

Port Inactivity Timer

When ports are connected to other ports, this timer is started. If there is no receiver activity on this port for the period determined by this timer, it will automatically be disconnected (unlinked) from whichever port to which it was connected.

***1005x** where "x" is the amount of time a connected port should remain connected to **this** port if there no is activity for x seconds. The range is 1 to 32767 seconds. The controller responds with "PORT x TIMER SET" (where x is the port number). **Note: Programming the timer to zero disables it.**

DTMF Mute Timer

If DTMF muting is enabled on a port, audio from its receiver is muted upon receipt of DTMF. Furthermore, if the DTMF Covertone is enabled on this port, it will be used during the mute period as well. When the COS closes, the receiver is again unmuted and (if enabled) the Covertone is stopped. But what happens if a signal remains on the receiver? Obviously, the receiver wouldn't unmute until after that signal went away.

To prevent this from becoming a problem, the DTMF Mute Timer will unmute the receiver and stop the Covertone after a DTMF digit is first received and after certain amount of time. As long as DTMF digits are received, this timer is reset and the muting and Covertone will continue until the user unkeys.

***1006x** where "x" is the amount of time in 100 milliseconds steps that the DTMF mute timer should generate DTMF cover tone and the receiver should remain muted between DTMF digits. The range is 0 to 9999 milliseconds (ms). For example, 1 = 100 ms, 7 = 700 ms, 50 = 5 seconds. Regardless of this setting, the receiver will unmute and covertone will be stopped immediately upon COS closure or the receipt of DTMF "#".

CTCSS Encode Dropout Timer

If you have connected the CTCSS encode control line to an external encoder, you can program this parameter to select how long encoded CTCSS will continue to be transmitted after the receiver COS drops.

***1007x** where "x" is the amount of time in seconds CTCSS should continue to be sent after COS closure. The range is 0 to 255 seconds.

Note: programming a 0 disables the timer and the CTCSS encode line will "turn off" immediately upon COS closure.

Note: See the command *1021 for selecting the CTCSS Encode polarity

Alarm Timers

When an alarm is triggered, a timeout timer starts to run. When this timer times out, that alarm will reset back to the off position. X equals the amount of time the timer should take to time out. The default value is 2 seconds and the range is 1 to 255 seconds.

- *1008x** Set Alarm 1 Timeout
- *1009x** Set Alarm 2 Timeout
- *1010x** Set Alarm 3 Timeout
- *1011x** Set Alarm 4 Timeout
- *1012x** Set Alarm 5 Timeout

Auxiliary Audio Timers

When you turn on one of the Auxiliary inputs, a timer is started. When this timer times out, that input will automatically be turned back off. The default time is 300 seconds (5 minutes) and the range is 1 to 32767 seconds.

- *1013x Set Auxiliary Input 1 Timeout
- *1014x Set Auxiliary Input 2 Timeout
- *1015x Set Auxiliary Input 3 Timeout

Alarm Debounce Timer

Each of the Alarm inputs incorporates a debounce algorithm, used to eliminate false triggers caused to "noisy" trigger signals. While the default value of 500 should be adequate under most circumstances, you can adjust this value if necessary. The range is 1 to 6000, with 6000 representing approximately 1 second.

- *1017x Set Alarm Debounce Timer

Kerchunk Filter Timer

This timer determines how long a signal must appear on a receiver before it will be recognized as valid, if Kerchunk filtering is enabled. The range is 1 to 6000, with 6000 representing approximately 1 second.

- *1018x Set Kerchunk Filter Timer

Pending ID Speech Timer

The RC-210 normally uses a spoken ID for its Initial ID (this is selectable with a programming command). The Pending ID may be done in speech or in CW, depending on the setting of this timer. This timer looks for activity on its respective port for the past X seconds. If there has been activity, the Pending ID will be done in CW, otherwise it will be made with the next Voice ID in rotation. Setting this timer to the value of the Pending ID Timer will make it NEVER use a Voice ID for the pending ID. Setting it to zero will make it ALWAYS use a Voice ID for the pending ID. The range is 1 to the value of the Pending ID Timer but is entered in seconds. For example, 10 minutes is 600 seconds.

- *1019x Set Pending ID Speech Timer

Examples (assuming the Pending ID Timer is set to 10 minutes):

- *1019 60 Look for activity for the last 60 seconds. If there has been, the next Pending ID will be CW otherwise it will be Voice
- *1019 600 Pending ID's will always be done in CW
- *1019 0 Pending ID's will always be done in Voice

Periodic Message Timer

This timer allows you to send programmed Tail Messages based on this timer instead of the number of transmitter "tails". When programmed, this timer starts to run upon COS closure on its Port and is reset if there is COS activity.

- *1020 300 Send currently selected Tail Message 5 minutes after last activity.
- *1020 0 Disable Periodic Messages

See the Tail Messages section of this manual for details on how Tail Messages work and how to program them.

CTCSS Encode Control Line Polarity

Each Port's CTCSS Encode Control Line may be programmed to be an active low or active open collector. In other words, you can program whether the Control Line should be pulled to ground or allowed to float when you want encoded by an external CTCSS encoder.

- *1021x Select Control Line polarity. If x = 1, then the output will float when active. If x = 0 then output will pull to ground when active.

Setting the Real Time Clock And Calendar

It is necessary to set the Real Time Clock and Calendar before you'll be able to use the features they provide, such as the time readback and the Scheduler. When programming, it will read back the current time in order to confirm your entry.

***5100 hh mm** where "hh" is the hours in 24 hour time and "mm" is the minutes. Both must consist of 2 digits

Examples:

***5100 01 22** Set the clock to 1:22 AM
***5100 15 04** Set the clock to 3:04 PM

***5101 mm dd yy** Set the calendar to MM month, DD day, YY year. When programming, the controller will read back the current day of the week, month, day and year in order to confirm programming.

Examples:

***5101 06 11 03** Set June 11, 2003 as the current date
***5101 10 04 11** Set October 4, 2011 as the current date

Year Readback

You may turn ON/OFF the readback of the year when the date is spoken.

***51020** Turn OFF year readback
***51021** Turn ON year readback

Adding A Correction Factor To The Real Time Clock

As is the case with any clock that is not referenced to standard such as WWV, the RC-210's Real Time Clock may gain (or lose) a few seconds over time. This is unavoidable due to temperature changes, crystal tolerances, etc. Fortunately, the RC-210 allows you to "bump" the clock + or - up to 60 seconds in order to obtain the best accuracy possible.

For example, you may notice after your RC-210 has been running for a week that its Real Time Clock has lost 2 seconds. With this command, it is a simple matter to add 2 seconds to the clock's time.

***5105 2** Add 2 seconds to the Real Time Clock's current time

***Note: If you need to subtract seconds from the Real Time Clock, preface the seconds with an "A". For example *5105 A 3 will subtract 3 seconds from the clock's current time**

In addition to adding 2 seconds to the time, this command also stores this correction factor into non-volatile memory. This allows you to set a scheduler setpoint (in our example above, you'd program a setpoint to run once a week) and automatically apply it to the clock by storing the Macro Function Number into a Command Macro and have the scheduler run that macro at, let's say, Friday night at midnight. See the Command Macro and Scheduler programming sections of this manual for details.

Remote Base Programming

The RC-210 is capable of controlling several different types of remotely controllable transceivers, for use as a remote base.

- Kenwood - All radios that utilize a computer interface that may be directly connected to an RS-232 compatible serial port.
- Icom models IC-706MKII and MKIIG
- Yaesu - FT-100D, FT-847, FT-817, FT-897

The RC-210 also supports the Doug Hall RBI-1 Remote Base Controller. Please refer to its respective manual when connecting the RC-210. You select which radio type you want to use by programming:

***2083x** where "x" is the radio type

1 = Kenwood

2 = Icom

3 = Yaesu

4 = Kenwood V7

5 = Doug Hall RBI-1

***For Kenwood radios that have a comport, the RC-210 uses a baud rate of 9600.**

***The RC-210 expects to see an Icom radio at the CI-V address of 48H with the baud rate set to 4800. Yaesu radios should be set to a 9600 baud rate.**

this supports the Kenwood TM-V7A and TM-G707

***Selecting the RBI-1 enables additional features. See the Command Reference**

If you select Yaesu, there is one more programming you must take (if not using Yaesu, you may disregard this step):

***2084x** where "x" is

1 = FT-100D

2 = FT817, FT-847, FT-897

Remote Base Prefix

You can define a prefix that must be prepended to the remote base commands. This allows you to customize the codes required. If changed from the factory default value of "A7", the new Remote Base Command codes must be prepended with the defined prefix code. For example, if you change the Remote Base Prefix Code to "AB", a user would need to enter "A B 3 x" in order to change modes.

***2060xxxx** Define Remote Base Prefix Code - maximum 5 digits. If "0" is entered, any existing code is erased, thereby allowing the factory default codes to be used.

Examples:

***2060 AB** Define Remote Base Prefix to be "AB"

***2060 0** Erase Remote Base Prefix

Programming The RC-210 Command Macros

In order for users to be able to control functions in the RC-210 without them being required to first unlock the controller, you define a *Command Macro*. Furthermore, each of the 90 Command Macros may be assigned a unique *Command Code*. You may use any valid DTMF digit in any code except for "#" as this is a reserved digit (command terminator).

Remember when programming Macro codes, each one MUST be unique. "12345" is unique from "54321" however.

Take the time to plan your code strategy prior to actually programming. You can program any of the Command Codes to be from 1 to 8 digits long.

It is strongly suggested that you plan ahead by making a list of command codes you want to program and then double check them for duplicates. If you accidentally program the exact same code into more than one Macro, only the first occurrence will work with subsequent occurrences being ignored by the controller. You will then have to identify with commands aren't working and re-program their code accordingly. Take the time to plan your code structure and you will avoid having to take these steps.

Some system owners prefer the concept of having a prefix for a certain group of commands in order to make them easier to remember.

For example, you could program a group Command Macros that all control link functions and then group them together. By assigning them to start with a prefix of "AB", it would be a simple matter to remember that the digit that follows the prefix controls a specific function of port linking.

AB1 - Link Port 1 to Port 2
AB2 - Link Port 1 to Port 3
AB3 - Link Port 2 to Port 3
AB4 - Link all ports
AB5 - Unlink Port 1 from Port 2
AB6 - Unlink Link Port 1 from Port 2
AB7 - Unlink Port 2 from Port 3
AB8 - Unlink all ports

Of course, these are strictly examples and only limited by a maximum of 8 digits for each Macro Command Code and your imagination!

Other system owners prefer a different code scheme and will assign commands based on different groups of users, such as general users and authorized Control Operators. Only some commands will be given to each group, with the Owner reserving programming commands and other deemed critical functions only for themselves.

Again, this is totally up to you and how you wish to organize your system. The RC-210 gives you the flexibility to do it any way you want.

Command Macros

The RC-210 allows for storing up to 90 different *Command Macros* that are stored in non-volatile memory and can be recalled with a single command. Each command in the RC-210 is assigned a Function Number (FN) that is used to store it in each macro (see the Macro List on Page 22).

Macros are programmed by first entering the macro programming command for the macro you wish to program, followed by a series of 3 digit function numbers to be programmed into that macro. The command syntax is:

***4002 mm xxx xxx xxx xxx xxx xxx xxx xxx xxx xxx xxx xxx xxx xxx**

where "mm" are 2 digits representing the macro (01-90) to be programmed, followed by a series of 3 digit numbers where "xxx" represents those commands.

Note: Long Macros will accept up to 15 3 digit function numbers while Short Macros will accept up to 4. Going over these limits will cause the controller to say "ERROR" and that Macro will not be stored.

For example, we want to program Macro 1 so it will turn on CTCSS Access on Port 1, connect Port 1 to Port 2 and change Port 2's courtesy tone to #4. By looking up these functions on the Macro Function Number chart, we see the function commands we want are 002, 019 and 059. We enter - all in one transmission:

***4002 01 002 019 059**

The controller responds with "M A C R O" and the number of the macro we just programmed.

We can even program macros to include other macros. For example, we want to create a macro that in addition to doing what Macro 1 already does, we also want it to change Port 1's courtesy tone to #9. Instead of having to repeat the commands previously stored in Macro 1, we can simply create a new macro containing the additional function and include Macro 1 as well:

***4002 02 054 401**

Macros may be embedded into other macros any number of times, up to the limit that macro can hold.

Using Command Macros To Remap Controller Functions

Another use for Command Macros is to allow user access to controller functions without having to first unlock a port. This gives you complete control over whom should have access to which functions in the RC-210.

Let's say you want your users to be able to read the RC-210's real time clock easily and you want them to enter "1111" with their radios in order to do so. First, we program a Command Macro for that function. In this example, we'll use one of the Short Macros - Macro 41 - since we only need it perform a single function:

***4002 41 116**

We can now assign Macro 41 the code of "1 1 1 1".

***2050 41 1111**

Now when someone enters "1 1 1 1", the RC-210 will speak the current time (provided you've set the clock that is!). It's that simple.

You can use any of the 90 Command Macros for remapping commands as needed.

Command Macro Priority

Command Macros have 3 different levels of priorities - low, medium and high.

- High - Once a Command Macro starts, nothing will stop it
- Medium - If a Command Macro contains any speech functions, that speech will be controlled by the Speech Override and Speech ID Override settings. This is the default priority level of all Command Macros.
- Low - Any COS activity on the last active Port will stop that Command Macro and exit.

Priorities are particularly useful for controlling Command Macros that contain speech. For example, you recorded a DVR track with an informational message, such as "This Repeater Requires a Tone Frequency of 100 Hertz", which plays immediately following an ID. Some users might take great delight in kerchunking in the middle of the informational message, stopping it because you have Speech Override turned on. By assigning this Macro a high priority, it will always play uninterrupted.

You assign a Command Macro a priority level by including one of the following function numbers within that macro, as the first one entered.

228 High Priority
229 Low Priority

Example: Command Macro 12 will play DVR Track 1 and then play an ID on Port 1, as High Priority:

***4002 12 228 162 126 181**

After a Command Macro runs, its priority level is automatically reset to Medium.

Message Macros

The RC-210 provides 40 *Message Macros* that can be used to store custom responses to user entered commands, scheduler events, Alarm events and so on. Each Message Macro can store up to 9 vocabulary words, DVR tracks or any combination of the two.

For example, Command Macro 42 is going to be used to re-map the Port 1 and Port Linking function. When a user uses this macro to link the ports, we want the controller to speak "Link Port One And Two". In our example, we'll use Message Macro #1. With the controller unlocked, we program:

***2103 01 139 181 001 063 002** programs Message Macro 1 to speak "Link Port One And Two"

Important: You must always use 3 digits for vocabulary words or DVR tracks, when programming Message Macros. Failure to do so will result in unpredictable results.

We now program Command Macro 42 to link the ports and also include Message Macro 1:

***4002 42 187 118**

Hint: notice that we entered the Message Macro function number first, then the function that actually connects the ports. You'll find that when linking ports, it works best if the message is first played then the link established. When unlinking ports, the actual unlinking function should be first, with the Message Macro being last. The reason being that if you have Monitor Mix and/or Speech Override selected for that port, any receiver activity will interfere with the Message Macro being spoken.

Tail Messages

There are 3 Tail Messages per port, which can be "played" based on either the number of repeater "tails" (hang time) or based on the Periodic Message Timer. Each Tail Message is programmed to use one of the 40 Message Macros.

***2110 x y** where x is the Tail Message number (1 - 3) and y is the Message Macro to use (1 - 40).

To select which Tail Message is to be used:

***2111 x** where x is the Tail Message Number to use 1, 2 or 3.

Note: Setting the Tail Message Number to 0 turns off all Tail Messages on that Port

To play a Tail Message based on the number of tails:

***2112 x** where x is the number of repeater tails from 1 to 254

To play a Tail Message based on the Periodic Message Timer:

***1020 x** Set the Period Message Timer to play the selected Tail Message x seconds after the last COS activity.

Note that it is possible to play a Tail Message based on both the Tail Counter AND the Period Message Timer. If you only want to use Tail Messages based on the Tail Counter, program the Period Message Timer to 0, which will disable it. Conversely, If you only want to use Tail Messages based on the Periodic Message Timer, program the Tail Timer to 0, which will disable it.

Tail Messages may be turned ON and OFF "on the fly" by using their appropriate Macro Function. See the Macro Function List for their Function Number.

Tail Messages are normally directed out the Port they were programmed from. In other words if you program Tail Messages for Port 1, then that Tail Message will only be sent out Port 1. The exception to this is if you have one or more Ports linked.

For example, Ports 1 and 2 are currently linked. The programmed Tail Message on Port 1 will be sent to both Ports. Likewise, any programmed Tail Message on Port 2 will likewise be sent to both Ports.

Some Practical Examples of Tail Message Programming

In this example, we will program Tail Message 1 to play Message Macro 1 every 10 tails:

We've recorded DVR Track 1 which says "The ARC will hold its meeting tonight at 7 PM" and store this into Message Macro 1:

***2103 1 236**

Now we program Tail Message 1 to use Message Macro 1

***2110 1 1**

Next, we program this port to use Tail Message 1

***2111 1**

Next, we program the Tail Counter to count 10 repeater tails:

***2112 10**

Finally, we disable the Periodic Message Timer

***1020 0**

Now DVR Track 1 will be sent every 10 repeater tails.

In this next example, we want to send this same DVR track to users 5 minutes after repeater activity ends. First, we disable the Tail Counter:

***2111 0**

Now we set the Periodic Message Timer to 300 seconds (5 minutes)

***1020 300**

Now DVR Track 1 will be sent 5 minutes after the last repeater activity.

And finally, we want to send DVR Track 1 every 5 tails AND 15 minutes after repeater activity ends.

First, we program the Tail Timer:

***2111 5**

Lastly, we program the Periodic Message Timer to 300 seconds:

***1020 300**

As you can see, there is a lot of flexibility in the use of Tail Messages.

Speech Control Within Command Macros

Normally, speech command acknowledgment is sent out to the port from which the command was entered. For example, if you link Ports 1 & 2, entering the command from Port 1, the command acknowledgment will only be sent to Port 1. And in the case of Scheduler called Command Macros, we need a way to tell the RC-210 which port(s) should be used when sending a speech announcement.

Under certain circumstances, you may want any such speech sent out to other ports as well. In the above case, it might be useful to have it sent to both ports involved so users on both ports are advised as to the current status of the link. One solution to this would have been for the firmware to automatically send speech to ports that are linked, but this creates a problem - what if one of the ports involved isn't used as a link but rather as a remote base? It's a bad idea to send speech acknowledgments and other "repeater" messages out a remote base since a remote base should emulate the operation of a simplex radio. Simple solution you say - "Why not just program the controller to send speech messages out both ports, unless the linked to port is configured to be half-duplex?"

With so many different system designs out there, many repeater systems use half-duplex links. If the controller did this routing automatically, you'd never be able to direct speech where you want it. So it seems we need more a more flexible solution than an automatic one.

The solution is to allow you to select, within a Command Macro, which port(s) should receive speech. In our example above, we decide we want speech to be sent out both Ports 1 & 2. We therefore program a macro that will link the two ports and also send speech to Ports 1 & 2:

***4002 10 165 118**

By recalling Command Macro 10, Ports 1 & 2 will be linked, with the connect message being sent to both ports.

Now we can program another Command Macro to disconnect the ports and send the speech where we want it:

***4002 11 165 122**

By recalling Command Macro 11, Ports 1 & 2 will be unlinked, with the disconnect message being sent to both ports.

Important: If a macro contains a speech direct command, the speech direct function code must be the first one used in that macro. This is important as if it doesn't appear first within the macro, speech may not be properly directed.

List Of Port Direction Commands For Use In Macros

162 Port 1	166 Ports 1 & 3
163 Port 2	167 Ports 2 & 3
164 Port 3	168 All Ports
165 Ports 1 & 2	

In addition to the above steering functions, you can also force the speech out the same port as the macro was called from. For example let's say you have macro 10 defined to send speech out Port 1 but there may times you may call that macro from one (or both) of the other ports. By including function 251 in your macro in addition to speech being routed to the ports you specified in that macro, speech would also be routed to the port you recalled that macro from.

Controlling Command Macro Access By Port

By default, any Command Macro will work from any Port. There may be times however, where you want to restrict access to a particular Command Macro to a certain Port or combination of Ports. You can then program which Port(s) to allow:

***4005 xx yyy** where "xx" is the Command Macro number (01 - 90) and "yyy" is the port(s) designation:

1 Port 1	13 Ports 1 & 3
2 Port 2	23 Ports 2 & 3
3 Port 3	123 All Ports*
12 Ports 1 & 2	

Note: If a port is unlocked, that port may run any macro, regardless of its access programming.

For example, you may only want users on Ports 1 and 2 to be able to link the two ports. In our example above, we programmed Command Macro 42 to link Ports 1 and 2 this. To restrict the use of this Command Macro to only Ports 1 and 2, we program:

***4005 41 12**

Note: You can change a previously defined port restriction by programming a new one "over the top" of an existing one.

Erasing All Command Macros

If you ever need to clear all the Command Macro port restrictions, you can use the following programming command:

***400699**

Erasing Command Macros

You may erase any Command Macro with the following command:

***4003 mm** where "mm" is the macro number 01-90.

Or you can erase ALL macros with:

***400499** Clears all Macros

Startup Macro

Macro 1 is a special case in that it is run every time the controller is powered up or otherwise resets. This allows you to define a known startup state of your RC-210. You may include any command within Macro 1, including calling other macros.

Special Features

Temporarily Disabling ID's And Timeout Timer

The RC-210 allows for easy use when "broadcasting" special events, such as a WestLink bulletin or Shuttle Audio event. By programming a Command Macro with the appropriate function(s), you can disable IDs on a Port and suspend its Timeout timer for 30 minutes. When the special event is over, you use another Command Macro to re-enable the IDs and timer. And if you combine these powerful features with the scheduler, you can set up the RC-210 to completely handle most of the tasks associated with this usually cumbersome chore.

Macro Functions

252	Stop ID And Disable Timeout Timer Port 1
253	Stop ID And Disable Timeout Timer Port 2
254	Stop ID And Disable Timeout Timer Port 3
256	Resume ID And Re-Enable Timeout Timer Port 1
257	Resume ID And Re-Enable Timeout Timer Port 2
258	Resume ID And Re-Enable Timeout Timer Port 3

Example: Program Command Macro 11 to suspend ID and Timeout Timer on Port 1, link Port 1 to Port 2 to allow a WestLink broadcast that is transmitted via a link on Port 2.

***4002 11 252 118**

If the event lasts longer than 30 minutes, you can simply run Command Macro 11 again to restart the 30 minute suspend period.

At the end of the event, Command Macro 12 to resume IDs and re-enable the Timeout Timer on Port 1, unlink Ports 1 & 2:

***4002 12 256 122**

DTMF Memories

There are 20 DTMF memories, which can store up to 10 DTMF digits each. This is useful for sending preformatted DTMF digits to one (or any combination) of the radio ports. Maybe you'll use them to control a remote link or an IRLP or EchoLink node.

Once programmed, the memories can then be recalled in any Command Macro.

***2105xx** y y y y y y y y where "xx" is the number of the memory (01-20) and y up to 10 DTMF digits.

DTMF Digits Duration and Time Between Digits

To accommodate different radio link paths, you can program both the duration and time between DTMF Memory digits:

***2106x** where "x" is the duration of each DTMF digit transmitted. The range is 1 to 255 milliseconds.

***2107x** where "x" is the time between DTMF digits. The range is 1 to 255 milliseconds.

Macro Function Number List

<u>FN</u>	<u>Description</u>	<u>FN</u>	<u>Description</u>
001	Port 1 Carrier Access	061	Port 2 Courtesy Tone 3
002	Port 1 CTCSS Access	062	Port 2 Courtesy Tone 4
003	Port 2 Carrier Access	063	Port 2 Courtesy Tone 5
004	Port 2 CTCSS Access	064	Port 2 Courtesy Tone 6
005	Port 3 Carrier Access	065	Port 2 Courtesy Tone 7
006	Port 3 CTCSS Access	066	Port 2 Courtesy Tone 8
007	Port 1 DTMF Covertone OFF	067	Port 2 Courtesy Tone 9
008	Port 2 DTMF Covertone OFF	068	Port 2 Courtesy Tone 10
009	Port 3 DTMF Covertone OFF	069	Port 3 Courtesy Tone 1
010	Port 1 DTMF Covertone ON	070	Port 3 Courtesy Tone 2
011	Port 2 DTMF Covertone ON	071	Port 3 Courtesy Tone 3
012	Port 3 DTMF Covertone ON	072	Port 3 Courtesy Tone 4
013	Port 1 Enable	073	Port 3 Courtesy Tone 5
014	Port 1 Disable	074	Port 3 Courtesy Tone 6
015	Port 2 Enable	075	Port 3 Courtesy Tone 7
016	Port 2 Disable	076	Port 3 Courtesy Tone 8
017	Port 3 Enable	077	Port 3 Courtesy Tone 9
018	Port 3 Disable	078	Port 3 Courtesy Tone 10
019	Monitor Port 1 from Port 2	079	Port 1 DTMF Muting ON
020	Monitor Port 1 from Port 3	080	Port 2 DTMF Muting ON
021	Disconnect Port 1 from Port 2	081	Port 3 DTMF Muting ON
022	Disconnect Port 1 from Port 3	082	Port 1 DTMF Muting OFF
023	Port 1 Monitor Mute	083	Port 2 DTMF Muting OFF
024	Port 1 Monitor Mix	084	Port 3 DTMF Muting OFF
025	Monitor Port 2 from Port 1	085	Control Receiver Override ON
026	Monitor Port 2 from Port 3	086	Control Receiver Override OFF
027	Disconnect Port 2 from Port 1	087	Read ADC Channel 1
028	Disconnect Port 2 from Port 3	088	Read ADC Channel 2
029	Port 2 Monitor Mute	089	Read ADC Channel 3
030	Port 2 Monitor Mix	090	Read ADC Channel 4
031	Monitor Port 3 from Port 1	091	Read ADC Channel 5
032	Monitor Port 3 from Port 2	092	Read ADC Channel 6
033	Disconnect Port 3 from Port 1	093	Read ADC Channel 7
034	Disconnect Port 3 from Port 2	094	Read ADC Channel 8
035	Port 3 Monitor Mute	095	UF1 ON
036	Port 3 Monitor Mix	096	UF1 OFF
037	Port 1 Full Duplex	097	UF1 Pulse
038	Port 1 Half Duplex	098	UF2 ON
039	Port 2 Full Duplex	099	UF2 OFF
040	Port 2 Half Duplex	100	UF2 Pulse
041	Port 3 Full Duplex	101	UF3 ON
042	Port 3 Half Duplex	102	UF3 OFF
043	Port 1 Speech Override ON	103	UF3 Pulse
044	Port 2 Speech Override ON	104	UF4 ON
045	Port 3 Speech Override ON	105	UF4 OFF
046	Port 1 Speech Override OFF	106	UF4 Pulse
047	Port 2 Speech Override OFF	107	UF5 ON
048	Port 3 Speech Override OFF	108	UF5 OFF
049	Port 1 Courtesy Tone 1	109	UF5 Pulse
050	Port 1 Courtesy Tone 2	110	UF6 ON
051	Port 1 Courtesy Tone 3	111	UF6 OFF
052	Port 1 Courtesy Tone 4	112	UF6 Pulse
053	Port 1 Courtesy Tone 5	113	UF7 ON
054	Port 1 Courtesy Tone 6	114	UF7 OFF
055	Port 1 Courtesy Tone 7	115	UF7 Pulse
056	Port 1 Courtesy Tone 8	116	Say Time
057	Port 1 Courtesy Tone 9	117	Say Date
058	Port 1 Courtesy Tone 10	118	Link Port 1 to Port 2
059	Port 2 Courtesy Tone 1		
060	Port 2 Courtesy Tone 2		

Macro Function Number List (continued)

FN	Description	FN	Description
119	Link Port 1 to Port 3	181	Force Next Voice ID In Rotation On Port 1
120	Link Port 2 to Port 3	182	Force Next Voice ID In Rotation On Port 2
121	Link All Ports	183	Force Next Voice ID In Rotation On Port 3
122	Unlink Port 1 from Port 2	184	Force Next CW ID In Rotation On Port 1
123	Unlink Port 1 from Port 3	185	Force Next CW ID In Rotation On Port 2
124	Unlink Port 2 from Port 3	186	Force Next CW ID In Rotation On Port 3
125	UnLink All Ports	187	Play Message Macro 1
126	Play DVR Track 1	188	Play Message Macro 2
127	Play DVR Track 2	189	Play Message Macro 3
128	Play DVR Track 3	190	Play Message Macro 4
129	Play DVR Track 4	191	Play Message Macro 5
130	Play DVR Track 5	192	Play Message Macro 6
131	Play DVR Track 6	193	Play Message Macro 7
132	Play DVR Track 7	194	Play Message Macro 8
133	Play DVR Track 8	195	Play Message Macro 9
134	Play DVR Track 9	196	Play Message Macro 10
135	Play DVR Track 10	197	Play Message Macro 11
136	Play DVR Track 11	198	Play Message Macro 12
137	Play DVR Track 12	199	Play Message Macro 13
138	Play DVR Track 13	200	Play Message Macro 14
139	Play DVR Track 14	201	Play Message Macro 15
140	Play DVR Track 15	202	Play Message Macro 16
141	Play DVR Track 16	203	Play Message Macro 17
142	Play DVR Track 17	204	Play Message Macro 18
143	Play DVR Track 18	205	Play Message Macro 19
144	Play DVR Track 19	206	Play Message Macro 20
145	Play DVR Track 20	207	Play Message Macro 21
146	Auxiliary Audio 1 ON	208	Play Message Macro 22
147	Auxiliary Audio 2 ON	209	Play Message Macro 23
148	Auxiliary Audio 3 ON	210	Play Message Macro 24
149	Auxiliary Audio 1 OFF	211	Play Message Macro 25
150	Auxiliary Audio 2 OFF	212	Play Message Macro 26
151	Auxiliary Audio 3 OFF	213	Play Message Macro 27
152	Alarm 1 ON	214	Play Message Macro 28
153	Alarm 2 ON	215	Play Message Macro 29
154	Alarm 3 ON	216	Play Message Macro 30
155	Alarm 4 ON	217	Play Message Macro 31
156	Alarm 5 ON	218	Play Message Macro 32
157	Alarm 1 OFF	219	Play Message Macro 33
158	Alarm 2 OFF	220	Play Message Macro 34
159	Alarm 3 OFF	221	Play Message Macro 35
160	Alarm 4 OFF	222	Play Message Macro 36
161	Alarm 5 ON	223	Play Message Macro 37
162	Speech Out Port 1	224	Play Message Macro 38
163	Speech Out Port 2	225	Play Message Macro 39
164	Speech Out Port 3	226	Play Message Macro 40
165	Speech Out Ports 1 & 2	227	Good Morning/Afternoon/Evening Runtime Variable
166	Speech Out Ports 1 & 3	228	Macro Priority High
167	Speech Out Ports 2 & 3	229	Macro Priority Low
168	Speech Out All Ports	230	Disable Kerchunk Filter Port 1
169	DTMF Enable Port 1	231	Disable Kerchunk Filter Port 2
170	DTMF Enable Port 2	232	Disable Kerchunk Filter Port 3
171	DTMF Enable Port 3	233	Enable Kerchunk Filter Port 1
172	DTMF Disable Port 1	234	Enable Kerchunk Filter Port 2
173	DTMF Disable Port 2	235	Enable Kerchunk Filter Port 3
174	DTMF Disable Port 3	236	Disable Receiver Port 1
175	Require CTCSS Port 1	237	Disable Receiver Port 2
176	Require CTCSS Port 2	238	Disable Receiver Port 3
177	Require CTCSS Port 3	239	Enable Receiver Port 1
178	Do not require CTCSS Port 1	240	Enable Receiver Port 2
179	Do not require CTCSS Port 2	241	Enable Receiver Port 3
180	Do not require CTCSS Port 3		

Macro Function Number List (continued)

<u>FN</u>	<u>Description</u>	<u>FN</u>	<u>Description</u>
242	Speech ID Override OFF Port 1	288	Enable Meter 1 Alarm
243	Speech ID Override OFF Port 2	289	Enable Meter 2 Alarm
244	Speech ID Override OFF Port 3	290	Enable Meter 3 Alarm
245	Speech ID Override ON Port 1	291	Enable Meter 4 Alarm
246	Speech ID Override ON Port 2	292	Enable Meter 5 Alarm
247	Speech ID Override ON Port 3	293	Enable Meter 6 Alarm
248	All Courtesy Tones OFF Port 1	294	Enable Meter 7 Alarm
249	All Courtesy Tones OFF Port 2	295	Enable Meter 8 Alarm
250	All Courtesy Tones OFF Port 3	296	Disable Meter 1 Alarm
251	Force Audio To Entered Port	297	Disable Meter 2 Alarm
252	Stop ID/Disable Timeout Timer Port 1	298	Disable Meter 3 Alarm
253	Stop ID/Disable Timeout Timer Port 2	299	Disable Meter 4 Alarm
254	Stop ID/Disable Timeout Timer Port 3	300	Disable Meter 5 Alarm
256	Resume ID/Enable Timeout Timer Port 1	301	Disable Meter 6 Alarm
257	Resume ID/Enable Timeout Timer Port 2	302	Disable Meter 7 Alarm
258	Resume ID/Enable Timeout Timer Port 3	303	Disable Meter 8 Alarm
259	Send DTMF Memory 1	304	Disable DTMF Aborts ID
260	Send DTMF Memory 2	305	Enable DTMF Aborts ID
261	Send DTMF Memory 3	306	Not Used
262	Send DTMF Memory 4	307	Not Used
263	Send DTMF Memory 5	308	Not Used
264	Send DTMF Memory 6	309	Bump Clock By Correction Factor
265	Send DTMF Memory 7	310	Say year as part of date
266	Send DTMF Memory 8	311	Don't say year as part of date
267	Send DTMF Memory 9	312	Port 1 Tail Message OFF
268	Send DTMF Memory 10	313	Port 2 Tail Message OFF
269	Send DTMF Memory 11	314	Port 3 Tail Message OFF
270	Send DTMF Memory 12	315	Port 1 Tail Message 1
271	Send DTMF Memory 13	316	Port 2 Tail Message 1
272	Send DTMF Memory 14	317	Port 3 Tail Message 1
273	Send DTMF Memory 15	318	Port 1 Tail Message 2
274	Send DTMF Memory 16	319	Port 2 Tail Message 2
275	Send DTMF Memory 17	320	Port 3 Tail Message 2
276	Send DTMF Memory 18	321	Port 1 Tail Message 3
277	Send DTMF Memory 19	322	Port 2 Tail Message 3
278	Send DTMF Memory 20	323	Port 3 Tail Message 3
279	Clear All Meter Hi/Low Trippoints		
280	Clear Meter 1 Hi/Low Trippoint		
281	Clear Meter 2 Hi/Low Trippoint		
282	Clear Meter 3 Hi/Low Trippoint		
283	Clear Meter 4 Hi/Low Trippoint		
284	Clear Meter 5 Hi/Low Trippoint		
285	Clear Meter 6 Hi/Low Trippoint		
286	Clear Meter 7 Hi/Low Trippoint		
287	Clear Meter 8 Hi/Low Trippoint		

351 - 370 Suspend Scheduler Setpoint 1 - 20

371 - 390 Resume Scheduler Setpoint 1- 20

401 - 490 Macro 1 - 90 (these codes can only be used inside another macro. It is not possible to recall them directly)

The Scheduler

The Scheduler lets you automate many routine tasks by defining a specific day of the week, the hour of that day and the number of minutes past the hour you wish that task to run. Such a definition is called a *setpoint*, which is programmed to run a specific macro at a specific time of day. Only macros may be run by the scheduler, however that macro may contain any command(s), including speech commands such as Time of Day.

Note: setpoints are one-shot events that occur only once at the scheduled time

One example of a setpoint would be if you wanted to link Port 1 to Port 2 for a net that lasts for an hour every Tuesday at 7 PM. You'd define a macro to link Port 1 to Port 2, then define a setpoint to call that macro at 7 PM. After the net is over, another setpoint could be defined to call a different macro that disconnects the ports.

How Do We Define Setpoints?

A programming commands allows us to program each setpoint by defining the time and day of week that setpoint should run and the macro to be executed. The format is:

***4001 SS DOW Hours Minutes Macro**

SS is the setpoint number 01-20 and must always be 2 digits

DOW is the day of week:

1 = Monday	6 = Saturday
2 = Tuesday	7 = Sunday
3 = Wednesday	8 = weekdays
4 = Thursday	9 = weekends
5 = Friday	0 = everyday

Hours and Minutes are the time in 24 hour format. For example, 10 24 = 10:24 am or 22 10 = 10:10 pm

Hint: The hours digits may be set to a wildcard value with a DTMF "0A". Setting the hours to "0A" causes a match every hour at "minutes" after.

Macro is the macro to be executed at the appointed time and may be any macro you have defined 01-40. You must use 2 digits.

More than one setpoint can be run at a particular time. For example, if more than one setpoint qualifies at a particular time, the lowest numbered one will be run first, then the next and so on. You can cancel any previously defined setpoint by setting it to a time that will never occur, i.e 25 00 hours.

Recurring Voice Messages

You may want to define a setpoint that announces the time every hour (using the hourly wildcard) during morning commute time on weekdays. Easy enough, we'll just program a setpoint to recall a macro that calls function 116 (Say Time), speak on Port 1 and call that macro with a scheduler setpoint to run every hour, starting at 6 AM. The RC-210 will now speak the time every hour, on the hour. But we have a problem now - there is no way to stop the hourly announcements without actually reprogramming that setpoint so that it doesn't announce the time any more. Since the controller will now announce the time every hour, 24 hours a day, this obviously doesn't work out the way we want!

So how can we stop that setpoint from continuing to run until we reprogram it? Without something to tell the scheduler to stop running that setpoint, in fact we can't. So once started, the controller is going to announce the time every hour until we do something about it.

In order to get around this problem, the RC-210 incorporates another set of commands that allow you to suspend a currently occurring setpoint without having to actually erase that setpoint. These commands are known as the Suspend and Resume commands. What the Suspend command does is to prevent a setpoint from occurring by setting a flag. The RC-210's program then knows that since the Suspend flag is set, it shouldn't continue to execute that setpoint. To start it running again, we simply use another setpoint to run another macro that calls the Resume command. The setpoint to announce the time is now free to run once more.

First, we program up the needed macros:

*4002 02 162 116 ←Macro 2 calls Say Time on Port 1
*4002 03 371 ←Macro 3 sets the Resume flag
*4002 04 351 ←Macro 4 sets the Suspend flag

Note: Since Macro 1 is called at controller startup, it should never be used to announce the time, since the clock will never be set at startup.

Now we program our setpoints:

*4001 01 8 0A 00 02 ←Call Macro 2 every hour on weekdays
*4001 02 8 06 00 03 ←Resume Macro 3 at 6 AM on weekdays (we don't need to use the Port setting here)
*4001 03 8 09 00 04 ←Suspend Macro 4 at 9 AM weekdays (again, we don't need to use the Port setting)

Now the controller will announce the time every hour on Port 1, starting at 6 AM on weekdays and stop announcing at 9 AM

Plan! Plan! Plan!

The most important step you can do is PLAN. You need to figure out exactly what you want the repeater to do, then how the scheduler should be programmed in order to accomplish that. The scheduler is pretty smart, but it can't read your mind!

First of all, let's decide on what we want the scheduler to do. Maybe you'd like to turn off certain features at night, leaving them on until later on the weekends for the night owls. Maybe you have a swap net on Mondays that you would like to monitor. You want to automatically link Port 1 to Port 2 5 minutes before the start time of the net and turn it back off when the net is over. During the weekday morning commute, you'd like to change to a different courtesy tone on Port 2 and announce the time every 15 minutes for the commuters. You also want to put all ports into CTCSS access mode between midnight and 7 am on weekends. Remember that the scheduler can only call macros, so we need to define some macros to do our bidding

From the above, we first define our setpoints and the macro we'll store the function in:

<u>Setpoint</u>	<u>Time</u>	<u>Day</u>	<u>Macro</u>	<u>Description</u>
1	6:00 am	weekdays	2	Weekday mornings - change to courtesy tone #2 on Port 2, announce the time
2	9:00 am	weekdays	3	Weekday mornings - back to courtesy tone #1 on Port 2, stop announcing time
3	7:00 pm	Monday	5	Turn link on for net
4	8:00 pm	Monday	6	Turn link off after net ends
5	12:00 am	weekdays	7	Change all ports to CTCSS access on weekends at midnight
6	6:00 am	weekdays	8	Change all ports to carrier access on weekend mornings at 7 am

We first need to program the appropriate macros to function those things we want changed:

*4002 02 163 061 116 Program Macro 2 to change to courtesy tone #2 on Port 2 and announce the time.
*4002 03 060 351 Program Macro 3 to change to courtesy tone back to #1 on Port 2 and suspend announcing the time.
*4002 04 371 Program Macro 4 to resume running Macro 1
*4002 05 118 Program Macro 5 to link Ports 2 & 3
*4002 06 122 Program Macro 6 to unlink Ports 2 & 3
*4002 07 002 004 006 Program Macro 7 to change all ports to CTCSS access
*4002 08 001 003 005 Program Macro 8 to change all ports to carrier access

We can now program the scheduler setpoints:

*4001 01 8 0A 00 02 Call Macro 2 at 6 AM on weekdays
*4001 02 8 09 00 03 Call Macro 3 at 9 AM on weekdays
*4001 03 8 06 00 04 Call Macro 4 at 6 AM to restart Macro 1
*4001 04 8 18 55 05 Call Macro 5 at 6:55 PM to link Ports 1 & 2
*4001 05 8 20 00 06 Call Macro 6 at 8 PM to unlink Ports 1 & 2
*4001 06 9 00 00 07 Call Macro 7 at midnight on weekends
*4001 07 9 07 00 08 Call Macro 8 at 7 AM on weekends.

As you can see, if you take the time to plan your setpoints, the RC-210 will handle many tedious chores for you, automatically.

Erasing SetPoints

You can erase any setpoint by simply programming a time that will never occur, i.e 2500 hours. However there may be times that you want to clear all setpoints and start "fresh". This command allows you to do so

***400799** Clear all setpoints

Voice Message Editing And IDs

<u>Command</u>	<u>Description</u>	<u>Maximum Number Of Words</u>
*8004	Voice ID #1	22
*8005	Voice ID #2	22
*8006	Voice ID #3	22

You may use any combination of vocabulary words and DVR tracks in all ID Voice Messages.

Important: You must always use 3 digits for vocabulary words or DVR tracks when programming ID Messages. Failure to do so will result in unpredictable results.

Hint: You may use AA1, AA2, AA3, AA4 and AA5 to review your stored ID's

ID Extras

ID Extras allow you to include special messages as part of your Voice ID's:

***8007x yy** where "x" is the ID of the currently unlocked port and "yy" is the extra message to use in that ID:

- 0 Cancel ID Extras
- 1 Say Good M/A/E BEFORE the ID
- 2 Say Good M/A/E AFTER the ID
- 3 Say the time BEFORE the ID
- 4 Say the time AFTER the ID
- 5 Say Good M/A/E and the time BEFORE the ID
- 6 Say Good M/A/E and the time AFTER the ID
- 7 Say Good M/A/E BEFORE the ID and say the time AFTER the ID
- 8 Say the time BEFORE the ID and Good M/A/E AFTER the ID
- 9 Say the time and Good M/A/E BEFORE the ID
- 10 Say the time and Good M/A/E AFTER the ID
- 11 Random rotation of 1 through 10.

Enable/Disable Voice IDs

You may disable all Voice ID's and force all ID's to be made in CW. By default, Voice ID's are enabled

***8008x** Enable Voice IDs
x = 1 Enabled* *Factory default
x = 2 Disabled

Using The Digital Voice Recorder (DVR)

The RC-210 includes an on-board DVR, which allows you to record up to 20 different "tracks" (messages) of audio. There is a total of 63 seconds recording time available, which can be divided up any way you like. You can have any combination of recorded tracks as long as the total time doesn't exceed the maximum recording time available. DVR tracks may be used in Voice ID's or Message Macros.

Recording DVR Tracks

To record a track, the controller must have one of its ports first unlocked. The syntax is:

***7001x** where "x" is the track number you wish to record 1 - 20

The controller responds with the number of seconds of recording time you have available and then says "Ready". At this point it is waiting for you to key before actually starting to record. You must start recording within 5 seconds after the controller speaks "Ready" or the command will be canceled. Once started, simply unkey to stop recording and your message is will be stored in memory. Don't worry if it's not perfect, as you have some editing commands available with which to "clean it up".

Playing A Recorded DVR Track

While in programming mode, you can use the following command to play back any recorded DVR Track. This is very useful to check the quality of your recording, both before and during editing.

123x where "x" is the DVR track to play 1- 20

Erasing Tracks

Once a track is recorded, it cannot be recorded again without first erasing it (this safeguard prevents you from accidentally recording over a previously recorded track). You can erase a particular track or, should you want to completely "wipe the slate clean", you may erase ALL tracks. When you erase tracks, the controller will let you know how many seconds recording time you have available after the track(s) is cleared.

***7002x** where "x" is the track number you want to erase 1 - 20

***700399** Erase all DVR tracks

Editing Recorded Tracks

Rarely will a recorded track be perfect, especially at the end of that recording. The DVR will faithfully record (and playback) whatever it is asked to - squelch bursts and other noise may appear at the end of your recording. The RC-210 gives you 2 commands with which to remove (or add) the last 200 milliseconds of a recording, which is very effective at editing those noises from the end of your recordings.

Let's say you've recorded an ID in Track 10 but at the end of it, there is a squelch burst. You can remove the last part of this track in 200 milliseconds increments by using the following command

***7004x** where "x" is the Track number to remove the ending 200 millisecond segment.

I can then use the ****123 10** command to play back Track 10 to see how it sounds.

It may be that you will need to remove more than one 200 millisecond segment - perhaps you stopped speaking and didn't unkey for longer time than you should have. You may remove as many segments as you need.

It is possible to remove too many segments, which results in chopping off too much from the end! Fortunately, the RC-210 lets you easily add back a previously removed segment with the following command

***7005x** where "x" is the Track number to add back the last removed 200 milliseconds segment.

You can add back as many segments as you need.

Finding Out How Much Recording Time You Have Left

The DVR will keep track of the total amount of recording time you have used. It will also let you know how many seconds of recording time you have left every time you record or erase a track (or erase all tracks). In addition, you can also use the following command at any time you're in programming mode to find out how many seconds of total recording time remain.

***70061** Read back the amount of available recording time, in seconds.

Notes:

When editing tracks, you must do so before you record any new ones or the results may be unpredictable.

Be ready to start speaking immediately when you start transmitting to minimize the amount of recording space used. You can not edit the beginning of a track.

Auxiliary Audio Inputs

Each of the 3 auxiliary inputs may be routed to any port's transmitter, or all of them.

***2100 x y** where "x" is the audio input and "y" is the port(s) that is sent the audio

x = 1 Aux Input 1

x = 2 Aux Input 2

x = 3 Aux Input 3

y = 1 Port 1

y = 2 Port 2

y = 3 Port 3

y = 12 Ports 1 & 2

y = 13 Ports 1 & 3

y = 123 Ports 1, 2 & 3

Resetting The RC-210

At times it may be advantageous to reset the controller. Doing this does two things. Firstly, it verifies the operation of the hardware watchdog timer. If you enter the Reset command and for some reason the watchdog timer fails, you'll receive a message saying "Timer Not Set". As it is a fail-safe message, you should never hear it. Upon a successful reset, you'll hear the power up message with the version number.

In addition to testing the watchdog timer, the reset command also forces the controller to start the controller from a known condition. Additionally if you have Macro 1 stored, the controller will run it upon reset.

***21999** Reset the controller

Note: Resetting the controller does not overwrite any custom programming you have made. In other words, a reset does not restore factory defaults

CW Speed Programming

*8000x where "x" is the speed of up to 2 digits. The allowable range is 5 - 50 wpm.

Examples:

*8000 5 Program CW speed to 5 wpm
 *8000 22 Program CW speed to 22 wpm

CW Tone Programming

Each Port's CW tone may be programmed to be a single or dual tone. If you use only 4 digits to program the tone frequency, the RC-210 will generate single tone CW. If you enter more than 4 digits, dual-tones will be generated:

*8001xxxx (xxxx) where "x" is the tone frequency in Hz of up to 4 (or 8) digits. The allowable range is 0 - 3500 Hz for each.

Examples:

*8001 800 Program cw tone of 800 Hz.
 *80011000 Program cw tone of 1000 Hz.
 *8001 0660 0440 Program dual tone of 660 and 440 Hz.

CW Message Programming

There are 2 CW ID messages, each of which may be programmed with up to 15 characters each (See Morse Code Character Table). They normally rotate as the Pending IDs. However if you have Speech Override ON and a signal appears on that port's receiver during a Voice ID, it will revert to CW and play CW message 2. To minimize disruption, it is recommended that you keep CW ID #2 as short as possible.

*8002xx-xx Program CWID #1
 *8003xx-xx Program CWID #2

Examples

*8002 21 42 06 53 32 12 21 82 92 Program "AH6LE/AUX" into ID #1
 *8003 21 42 06 53 32 12 72 Program "AH6LE/R" into ID #2

Notes:

- 1) The spaces between characters in the above examples are not used in actual programming. They are shown only for clarification purposes.
- 2) If you exceed 15 characters, all characters that follow will be ignored.

Figure 6 below shows the relationships between the codes and the layout of a standard Touchtone® pad. As you can see, it makes it easier to remember the code for a particular character without having to look up codes (Q and Z are treated as special cases).

Fig 6 Morse Code Character Table

A	21	U	82	Word	
B	22	V	83	Space	11
C	23	W	91	-	10
D	31	X	92	/	12
E	32	Y	93	AR	13
F	33	Z	90	,	14
G	41			?	20
H	42	0	00	SK	60
I	43	1	01		
J	51	2	02		
K	52	3	03		
L	53	4	04		
M	61	5	05		
N	62	6	06		
O	63	7	07		
P	70	8	08		
Q	71	9	09		
R	72				
S	73				
T	81				

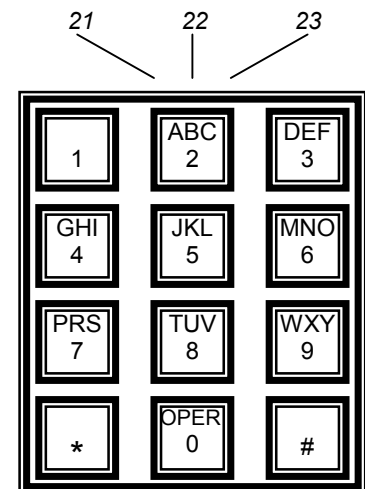

Courtesy Tone Programming

There are 10 sets of courtesy tones for each port that you can custom program. Each Courtesy Tone can be defined with up to 4 tone segments, duration of those segments and delays between segments. Courtesy tones consist of:

Delay time from the end of a user transmission (when the squelch on a port closes)

The 1st tone segment

Delay time from the end of the first tone segment.

A 2nd tone segment

Delay time from the end of the 2nd tone segment

A 3rd tone segment

Delay time from the end of the 3rd segment

A 4th tone segment

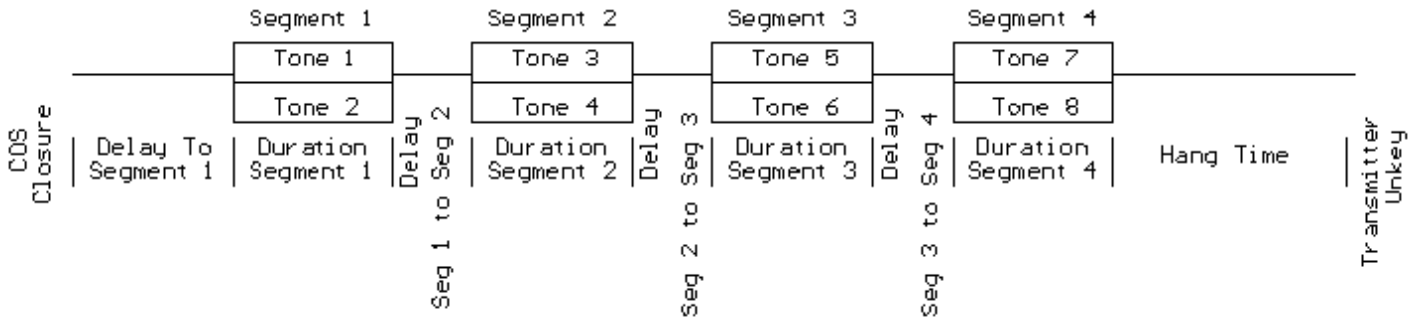

To program the courtesy tones, the following command is used. Each of the 4 segments have their own programming code.

***31CT** Delay to segment 1 # duration of segment 1 # Tone 1 # Tone 2 #

***32CT** Delay to segment 2 # duration of segment 2 # Tone 1 # Tone 2 #

***33CT** Delay to segment 3 # duration of segment 3 # Tone 1 # Tone 2 #

***34CT** Delay to segment 4 # duration of segment 4 # Tone 1 # Tone 2 #

CT refers to the courtesy tone set you wish to program and is entered as 01, 02, 03 and so on, up to 10. The delay and duration parameters are in milliseconds (ms) and the tone parameters are in hertz (hz). The # separators must be used.

While each segment allows two tones to be programmed, you can zero out either one for single tones.

Examples:

Program Courtesy Tone 1 to a single 1000 hz tone, 75 ms long, that starts 100 ms after COS closure:

***3101 100 # 75 # 1000 # 0 #**

or

***3101 100 # 75 # 1 # 1000 #**

Both of the above are identical in function.

Program Courtesy Tone 2 for multiple segments.

Segment 1 - dual tones, 880 and 660 hz, 75 ms long, that start 100 ms after COS closure

Segment 2 - dual tones, 1000 and 880 hz, 50 ms long, that start 75 ms after segment one finishes

***3102 100 # 75 # 880 # 660 #**

***3202 75 # 50 # 1000 # 880 #**

You can erase any segment by entering null information for it. For example, to completely erase Courtesy Tone 3, segment 3, you can enter

***3303 #**

Courtesy Tone Behavior When Ports Are Linked

When one or more ports are linked together, additional courtesy tones are sent to allow easy identification of the signal heard. For example, if you have Ports 1 and 2 linked and you're currently talking on Port 1, you'll hear an additional courtesy tone whenever someone unkeys on Port 2.

Courtesy Tone #9 is played if the signal comes from the "previous" port and Courtesy Tone #10 is played if the signal comes from the "next" port. The relationship between ports is described below:

Previous Port

If your currently used Port is 1, the Previous Port is 3
If your currently used Port is 2, the Previous Port is 1
If your currently used Port is 3, the Previous Port is 2

Next Port

If your currently used Port is 1, the Next Port is 2
If your currently used Port is 2, the Next Port is 3
If your currently used Port is 3, the Next Port is 1

For example, Port 1 is linked to Port 2 and a signal arrives on Port 2's receiver. From our list above, we see that Port 2 is Port 1's "next" Port, so Port 1's Courtesy Tone #10 will be sent whenever the signal on Port 2's receive disappears.

Accordingly, we can program Port 1's Courtesy Tone #10 the way we want it to sound.

Programming Meter Faces - 10-bit A/D Converters

The command syntax is:

***2064 C# M# X1# Y1# X2# Y2#** C= Channel 1 to 8 M=Meter Type 0 to 6 X1, Y1, X2, Y2 represent two calibration points. There must be 6 parameters entered to define a meter face, each value ending with #.

There are 8 meter faces corresponding to the 8 Analog inputs, with each meter face programmed with 1 of 6 values. The programming command consists the **input port**, meter **face type (name)**, and **4 values** representing:

- The low sensed voltage appearing on an input (X1)
- The low meter face reading (Y1)
- The high sensed voltage appearing on an input (X2)
- The high meter face reading (Y2)

Each meter face is calibrated with two *points* to define the sensor you wish to use on that channel. To clear a meter face, simply enter the input port number, then 0 for the meter face name and 4 more 0s, separated by a # sign, to complete the 6 values needed to define a meter face.

A "Meter Face" is an imaginary software meter that is defined by selecting which of the 8 analog inputs you will use, what kind of measurement is being made (volts, amps, etc.) and two data points on the meter. While this may seem confusing at first, the advantage of this method is that it allows you complete flexibility in scaling a particular meter face to the voltage actually being measured. The definable meter faces are:

- 0 Meter OFF
- 1 Volts
- 2 Amps
- 3 Watts
- 4 Degrees
- 5 MPH
- 6 Percent

Note: The calibration data (X1, Y1, X2, Y2) is the actual data that you have measured multiplied 100 and rounded off to the nearest whole number. The controller divides your input values by 100 to reestablish the decimal point.

Wattmeter example: If the output of your wattmeter produces 0.25 volts for 10 watts and 2.1 volts for 40 watts you would multiply each of the calibration values by 100 before you enter them:

.25 x 100 = 25	←Low voltage actually appearing on the ADC pin (X1)
10 X 100 = 1000	←Low meter face reading (Y1)
2.1 x 100 = 210	←High voltage actually appearing on the ADC pin (X2)
40 x 100 = 4000	←High meter face reading (Y2)

We wish to use ADC channel 6 for the Watt meter sensor (meter face 3) using the above calibration data, so we would program:

***2064 6# 3# 25# 1000# 210# 4000#**

Voltmeter example: You want to use ADC channel 4 for a Voltmeter (Meter face 1) and you have a sensor that produces 0 volts when the voltage is 0, and it produces 2.5 vdc when the actual dc voltage is 20 volts. Multiplying the sensor and actual data by 100 and rounding produces X1=0 Y1=0 X2=250 Y2=2000. To define this meter, you would enter the following program codes:

***2064 4# 1# 0# 0# 250# 2000#**

Notice that the same programming code (*2034) is used to setup each of the 8 ADC inputs.

Percent (Quieting) Meter Example: You want to assign ADC port 2 to Percent Quieting. You have a sensor that measures FM discriminator "noise" by rectifying it (similar to the way an S-meter works on FM). More noise means less quieting. You notice full quieting (100 percent) produces about 0.2 volts on the sensor, and no signal on the input (Zero percent) produces about 1.84 volts on the sensor. X1=0 Y1=100% X2=1.84 Y2=0%. To define this "Percent quieting" meter on ADC port 2 with these values you enter:

***2064 2# 6# 20# 10000# 184# 0#**

If someone with a full quieting signal accesses this meter, it might say "95 percent" or some reasonable indication of high quieting. **Data Entry Limits:** Physical values must be between -327 and +327 AND the difference between High and Low cannot exceed 327. A range of 0 to 327 is okay, or -150 to +150. Also, calibration points should be in the range of actual expected meter readings.

Programming Meter Alarms

Each of the Meters has a high and low alarm *trippoint*. Once programmed, when a meter reading reaches either of these points, a Command Macro will be run. For example, a meterface can be defined to read temperature from an external sensor. If the measured temperature exceeds the programmed high level, a Macro will be run. If the temperature drops below the programmed low limit, a Macro will be run. Of course the same Macro can be programmed for both the high and low points but different macros will generally be used for each trippoint. The format for programming a meter alarm is:

***2066 alarm number # meter number # alarmtype # trippoint # macro to run #**

There are 10 meter alarms, 1 through 10

Meter Number is 1 through 8 (for the ADC channels)

AlarmType determines the action taken by that alarm:

- 0 - OFF
- 1 - Low Alarm
- 2 - High Alarm
- 3 - Readback the current setting of that Alarm
- 4 - Clear all Alarms

Trippoint is the value to use for the high or low setting, multiplied by 100 and rounded to the nearest whole value. In our example above, we defined the meterface to measure temperatures from -35 to +150 degrees. We want our high trippoint to be set to +100 degrees, so we take "100" and multiply by 100 which gives us "10000". This is the number we enter for the trippoint value. If we want to enter a negative value for the trippoint (for example, -10 degrees), we simply preface the calculated value with a DTMF "A". For example, we want to set the low trippoint to -10 degrees. $-10 \times 100 = -1000$, so we would enter "A1000" for the trippoint value.

Macro to run is the Command Macro we want to be executed when our alarm trips.

A Practical Example

Let's say that we have a temperature sensor connected to Meter Input 1. We also have the PA power control line connected to Logic Output 5. Once our meterface is programmed (as shown in the Programming Meter Faces section above), we want to program a Meter Alarm to put the PA into its low power mode when the sensed temperature rises above 135 degrees. Since our PA control line requires that it be pulled to ground in order to enter low power mode, we need to turn ON the appropriate logic output and we'll use Command Macro 22 for this. And since this is our first Meter Alarm definition, we'll use Meter Alarm 1.

First, we program Macro 22 to turn on Logic Output 1

***4002 095**

Now we program the Meter Alarm itself

***2066 1 # 1 # 2 # 13500 # 22 #**

Now, if the sensed temperature rises above 135 degrees, the PA control line will be pulled low. Of course, we'd like a way to put the PA back into high power mode once the temperature drops back down to a safe temperature. We decide that once the PA temperature falls back down to 80 degrees, it is safe to put it back into high power mode. We'll use Meter Alarm 2 and use Macro 23 to turn Logic Output 1 back off.

***2066 2 # 1 # 1 # 8000 # 23 #**

When the sensed temperature falls below 80 degrees, the PA will be put back into high power mode.

The Differences Between Accuracy And Precision

It is easy to become confused when the issues of precision and accuracy are raised. Let's take a few minutes to understand what these terms mean in relation to the RC-210. The RC-210 can provide accurate measurements good to 3 decimal places of precision, if you take the time to setup the inputs correctly. It might help to explain accuracy and precision to understand how to improve both:

Accuracy - The ability of a measurement to match the actual value of that which is being measured. For example, if you measure 3.32 volts, knowing the voltage you're measuring is actually 3.32 volts. The RC-210 has a built-in reference voltage of 2.56 volts that is supposed to be accurate. You can also provide an external reference voltage. The accuracy of the reference voltage, V_{ref} , is the major factor in determining the overall accuracy of the A/D conversion process.

Precision - The number of significant digits to which a value has been reliably measured. The precision of the RC-210 is dependent on the 10-bit A/D converter. With 10-bits, the A/D device can distinguish among 1024 separate values in the input, from 0 volts to V_{ref} , which is roughly about 5 volts). If your sensor puts out 0 volts at the lowest expected level of the quantity it is measuring, and V_{ref} (5.00 volts for example) at the highest expected level of the quantity you are measuring, you will have all 10 bits of precision available to measure the physical quantity.

The next major issue in getting precise measurements is the characteristics of the sensor you use (design, buy, etc.) and how well it matches the A/D converter measurement range (0 to V_{ref}) when measuring physical quantities.

Suppose you want to measure 0 to 100 watts with a sensor and feed the sensor voltage to the controller to read back watts. You have a sensor to monitor the power of your repeater transmitter. You have measured the output of your sensor while measuring the power output on a calibrated watt meter and record the following values

At 0 watts the sensor produces 0.1 volts
At 100 watts the sensor produces 0.6 volts

As you can see, this is a small range of sensor voltage output -- only 0.5 volts. If V_{ref} is 5 vdc, this is using only 10.0% of the full range of the A/D input. Therefore, only 10.0% of the possible 1024 distinct measurement values is being used, or about 102 distinct measurement points. The range of Watts being measured is 100 watts. Dividing this 100 watts by the 102 points of resolution means the meter will be able to resolve about 1 watt per "division" which is not bad! However if you wanted more precise readings, find a sensor that produces a wider output voltage. For example, a sensor that produces 0.2 volts at 0 watts, and 4.2 volts at 100 watts. Now the sensor voltage range is 4 volts of the 5.0 vdc V_{ref} maximum. This is 80 percent of the 1024 points of resolution, or about 800 distinct measurement values. Now, for the same 100 watt range being measured, your improved sensor would now have a resolution of $(100 \text{ watts}) / (800 \text{ divisions}) = 0.125 \text{ watts per "division"}$. As you can see, a sensor that uses more of the V_{ref} voltage range increases the precision of your measurement.

In conclusion, the RC-210 can resolve a sensor voltage change of as small as $V_{ref} / 1024$. However, as you can see from the above example, the resolution of the physical "thing" being measured is directly affected by the behavior of the sensor. For best results, try to find sensors that produce sensor output voltages between 0 and V_{ref} over the range of desired physical measurements. This isn't an absolute requirement to get useful and accurate readings, but it will help increase the precision of the measurements.

Programming the Reference Voltage Value for the A/D Converters

As it comes from the factory, the RC-210 comes with the reference voltage value programmed to 5.00 volts. Since component tolerances obviously vary, you will want to measure the actual reference voltage of your RC-210 and then program that value into the controller. **Note: This one reference voltage is used by all the A/D inputs. Setting it accurately will improve the measurement accuracy.**

How to measure the V_{ref} : Using a high impedance, precision voltmeter (a digital, not an analog one is recommended) and with power applied to the RC-210, carefully measure the voltage at pin 21 of the I/O connector, J1. Write this voltage down - it is only necessary to include two decimal places). For example, if your meter displays "4.962", simply round it off to "4.96". Multiply this value by 100 as our value to enter as V_{ref} . The example below shows how to enter this measured V_{ref} .

*2065 4 9 6

Note: NEVER apply voltages higher than 5.2 volts to any A/D channel input. It is best to keep any input voltages at or below V_{ref} .

Measuring Voltages Higher Than Vref - A Practical Example

The voltage applied to an A/D input cannot exceed Vref, which is 5.00 volts by default.

The first step is to decide what the range of actual voltages will be measured:

Suppose the Low end of expected actual voltage 10 volts, and the High end of the expected actual voltage is 18 volts

Since we realize that applying a voltage to the RC-210 higher than the programmed reference voltage will "pin" the meter face, we need to "scale" the actual voltage. This can be accomplished using either a pair of resistors as a voltage divider, or a variable resistor to get just a portion of the 18 volts as the maximum value to connect to the ADC input. Using a 5-K pot would be a good choice.

What you want is to have the High end of voltage range (18 volts) to be less than Vref. If Vref is 5.00 volts, you might choose to set the resistor divider (or variable resistor) to produce 4.5 volts as the "sensor" voltage when the actual voltage is 18 volts.

If we look at the math, we see that 4.5 volts is 18 volts divided by 4 so the "sensor" needs to provide $\frac{1}{4}$ of the actual voltage. If the power supply is currently providing 13.8 volts, divide this by 4 to get 3.45 volts. If you are using a variable resistor (as shown in the Hardware Reference Manual), hookup your "sensor" to the battery, and adjust the pot to produce 3.45 volts on the wiper. This "sensor" will work fine with the ADC input. If the battery voltage ever gets to 18 volts, the wiper of the pot will see 4.5 volts, below the Vref of 5.0 volts, which is what is desired.

We then need to program the meter face used. For this example, we will use Meter 1 and assume the Voltage Reference Value has been left at the factory default of 5.00 volts:

***2064 1# 1# 250# 1000# 450# 1800#**

This programs Meter 1 to use the voltmeter meter face and tells the controller that when the sensor is 2.5 volts, this means the actual voltage is 10 volts, and when the sensor (ADC input) is 4.5 volts, the actual voltage is 18 volts. Note that each of the calibration points is the actual measured value multiplied by 100 then rounded to the nearest whole value. This is done because there is no "decimal" point on the DTMF pad, so the controller assumes that the "real" values are whatever you put in, divided by 100.

Using the above example, you should be able to accommodate just about any external sensor.

Alarm Programming

The RC-210 incorporates 5 alarm inputs that can be used to remotely monitor such things as a door open, high temperature of the repeater PA, etc. All you need do is supply a signal that goes to ground when active. When enabled (and triggered), each alarm will call a macro to execute. Alternately, you can program any alarm to route one of the Auxiliary Audio Inputs to the port of your choice.

For example, you could connect Alarm 1 to an over-temperature switch on the repeater's PA heatsink. You could program a macro that turns one of the logic outputs on (or off as needed) to select high/low power on the transmitter and speak a message to let you know. Should the PA overheat, the switch would pull Alarm 1 to ground, which in turn causes Alarm 1 to trigger, the repeater is placed in low power mode and an announcement is made over the air, every 30 seconds, until you clear it. Once the PA cools down to the point the Alarm is no longer triggered, you can put the repeater back into high power.

Or perhaps you want to connect a weather receiver with S.A.M.E. alerts at the repeater. All you need is a signal from the receiver that goes to ground whenever a S.A.M.E. alert is broadcast and connect the audio output to one of the Auxiliary Audio Inputs. By programming that Alarm to route that Auxiliary Audio Input to the port of your choice, you'll automatically be notified whenever the NOAA sends an alert.

Using Auxiliary Audio Inputs With An Alarm

If we want to program an Alarm to turn on an Auxiliary Audio Input:

***2101 <Alarm #> <Use/Not Use> <optional Port Identifier>**

Examples:

***2101 1 1 3** Turn on Auxiliary Audio Input 3 when Alarm 1 is triggered

***2101 5 1 2** Turn on Auxiliary Audio Input 2 when Alarm 5 is triggered

***2101 3 0** Alarm 3 doesn't use any Auxiliary Audio Input

Note: when selecting not to use an Auxiliary Audio Input for a particular Alarm, entering a "0" will allow the use of a macro. As in the example above, you do not need to use the optional Port number

Using Auxiliary Audio Inputs With A Macro

If we want to program an Alarm to call a macro:

***2102 <Alarm #> <Macro #>**

Examples:

***2102 5 22** Alarm 5 calls Macro 22

***2102 1 5** Alarm 1 calls Macro 5

Note: If you use a Macro with an Alarm, you must first make sure to turn off any Auxiliary Audio Inputs for that Alarm, using the *2101 command.

Alarm Timers

Each of the 5 Alarms may be programmed for how long they remain active once they have been triggered. All alarm timers may be programmed from 0 to 255 seconds.

***1008xx** Alarm 1 Timeout Period

***1009xx** Alarm 2 Timeout Period

***1010xx** Alarm 3 Timeout Period

***1011xx** Alarm 4 Timeout Period

***1012xx** Alarm 5 Timeout Period

Resetting The Unlock Codes

Should you ever need to reset your unlock codes back to the factory defaults, you may do so without erasing your custom programming. You accomplish this by powering down the controller and temporarily removing the push-on jumper from Port 3's CTCSS polarity selection header (JP5) and grounding the pin 2 (the center pin). Leaving the temporary jumper in place, power up the controller. After the controller speaks its version number and says "READY", all 3 Unlock codes will be set back to their default values. You may then remove the temporary ground connection from JP5 and reinstall the push-on jumper.

Updating The Firmware

The RC-210 was designed with ease of firmware upgrades in mind. This allows it to be easily upgraded in the field as new firmware versions are released.

In order to install these updates into the RC-210, you will need 2 things

- Free software from mcselec.com
- A programming cable between your PC's printer port and the RC-210's programming connector

Downloading And Installing The Required Software On Your Computer

The programming software may be downloaded at the following web site:

http://www.mcselec.com/download_avr.htm

Download all four disks and the help files. You may want to download the manual as well, but this is optional. Follow the installation instructions at their website for installing the software.

Programming Cable

In addition to the software, you will also need a special programming cable that connects from a printer port on your Windows® computer to the programming port on the RC-210. You can purchase a programming cable from us for \$25, or you can build one yourself. If you're interested in purchasing one that is "plug and play", please visit:

<http://www.ah6le.net/arcom/program.html>

If you chose to build your own, you will need a male DB25, 3 ea. 100 ohm 1/4 watt resistors, a 10 pin, 2 X 5 IDC header connector and a 10 conductor cable. While not absolutely necessary, we recommend using a shielded cable if the length will be over 3 feet. In any case, the cable should not be longer than 5 feet.

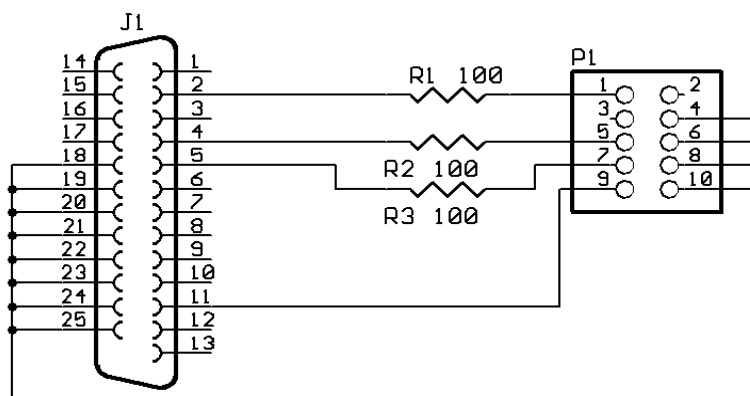

Downloading Firmware Updates

Once you've installed the program on your computer and have the programming cable, you'll need to download the firmware update from our website:

<http://www.ah6le.net/arcom/rc210/updates.html>

We recommend that you create a directory dedicated to firmware updates. As an example, you could name it "updates", but you may call it anything you like. Once downloaded, unzip the update into this directory. Remember the location of this directory as you'll need it later. All updates contain 4 files - one with a .bas extension, one with a .cfg, another with a .dbg and finally one with a .bin extension.

IMPORTANT: If you are running Windows XP®, it is very important that read the end of this section before actually trying to program your RC-210.

Configuring The Bascom Program For The First Time

When you first run Bascom, you need to configure certain things. Once you have done so, you should not have to change it unless you change the configuration of your computer's printer port.

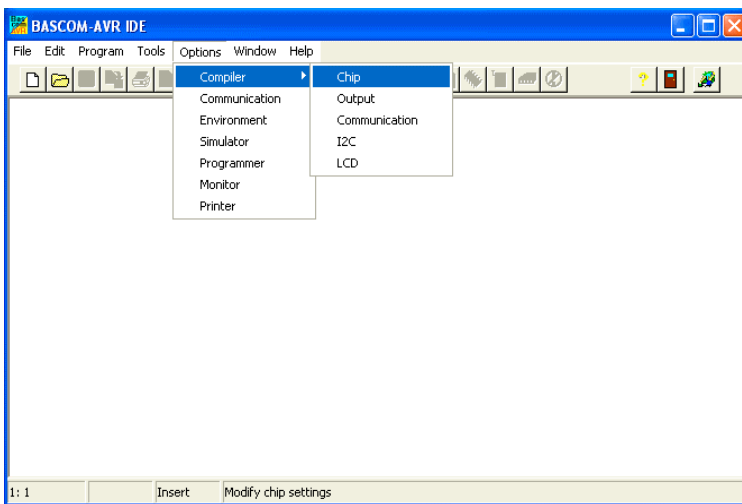

Open Bascom and click on Options > Compiler > Chip.

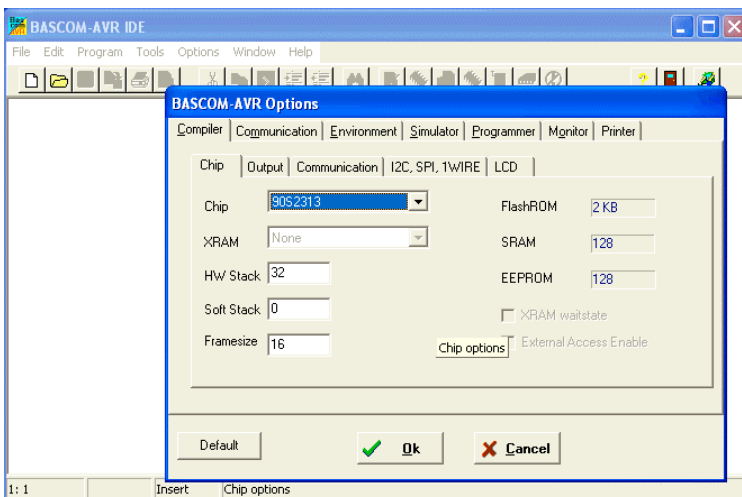

A new window will open. You may ignore what is presented for now. Click on the Programmer tab

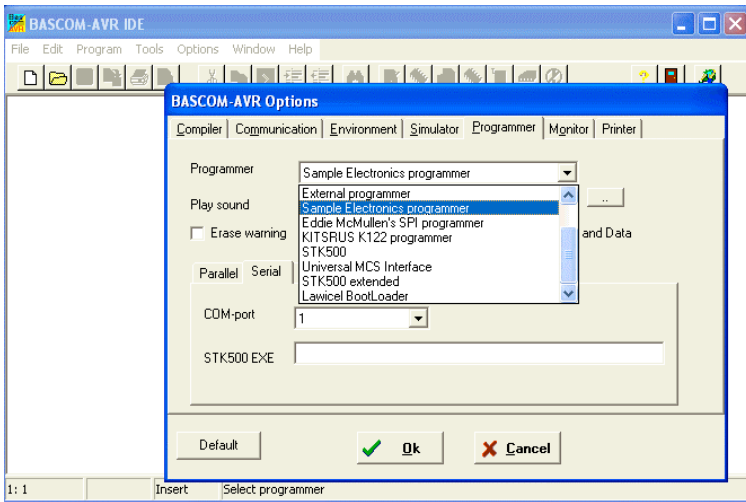

In the Programmer window, click on the down facing arrow on the right side of the text box. Scroll down to select Sample Electronics programmer and double click on it.

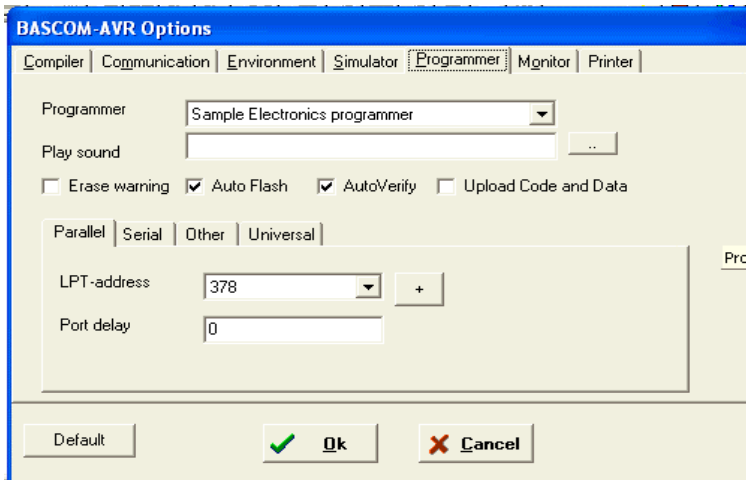

Check the Auto Flash checkbox. Click on the Parallel tab. If you're using Printer Port 1, LPT1 (the usual setting for most computers), you can leave the setting at 378, otherwise change it to the appropriate printer port. Click OK to save your settings.

Unless you change printer ports in the future, you shouldn't have to do this process again. From now on, you may start at the next step, after launching the program.

Opening the Firmware Update

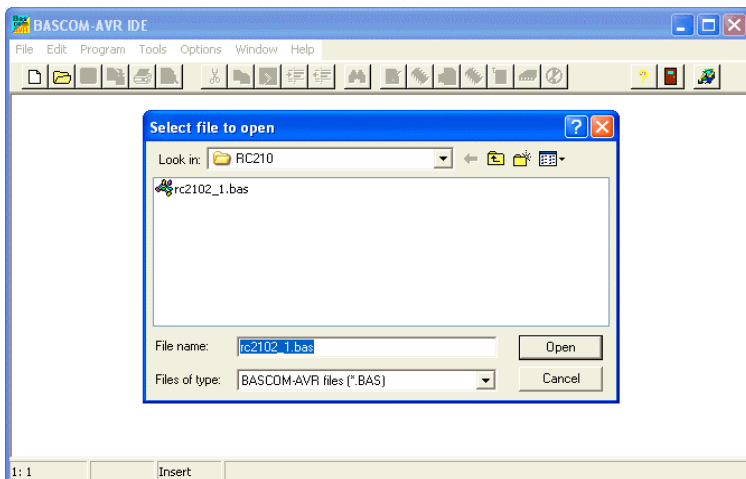

Click on File > Open. Use the usual Windows® method to change to the directory where you unzipped the firmware update you downloaded from our website.

Once you find the update (it will always have the extension of .bas, although the overall name will change depending on the version number).

Click on the Open button.

Loading the Firmware Into The RC-210

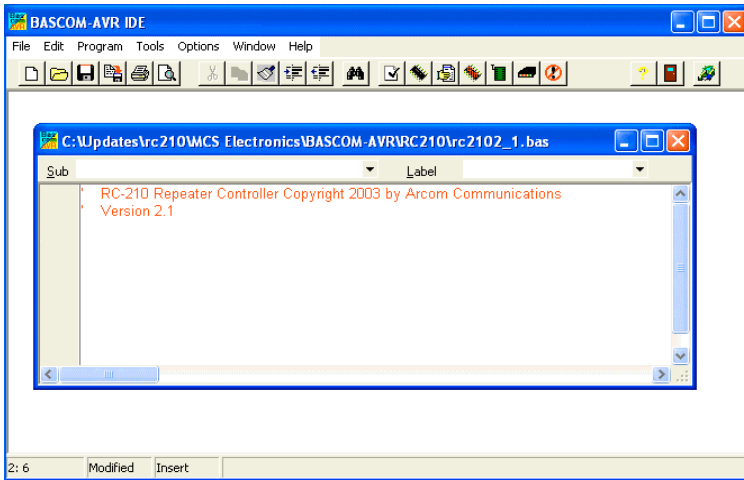

You will see a new window with the version number of the firmware. You are now ready to actually program your RC-210. Make sure the programming cable is plugged into your computer's printer port (the one you selected earlier) and your RC-210. The RC-210 may be left powered up while connecting the cable. Temporarily remove jumpers JP15 and JP16 (this removes the serial driver from the circuit to avoid interference issues)

IMPORTANT! When connecting the RC-210 end of the cable to the programming connector J5, make sure the stripe on the cable is on the same side of the 10 pin connector as the number 1 on the PC board. Failure to heed this may damage your RC-210 or computer!

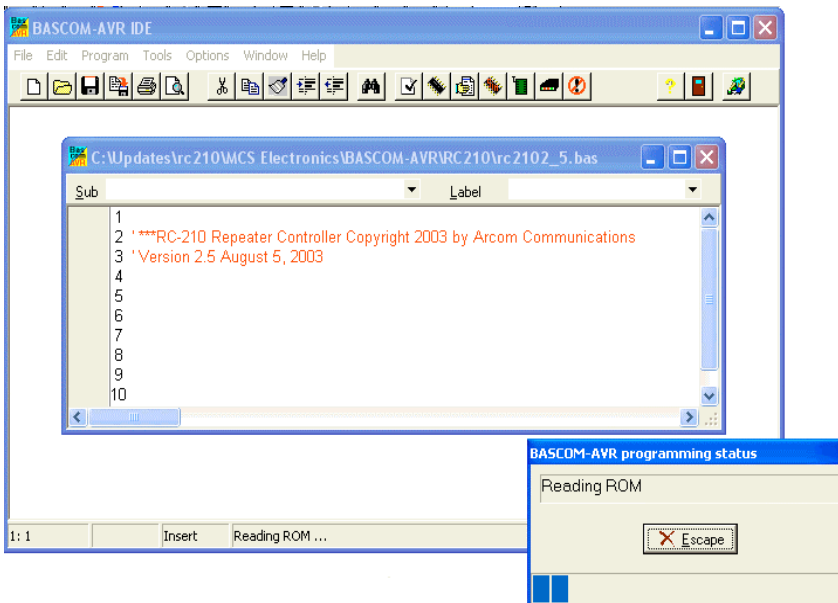

You are now ready to actually program your RC-210.

Press F4 on your keyboard and a new window will pop up, showing the progress of the write cycle of programming.

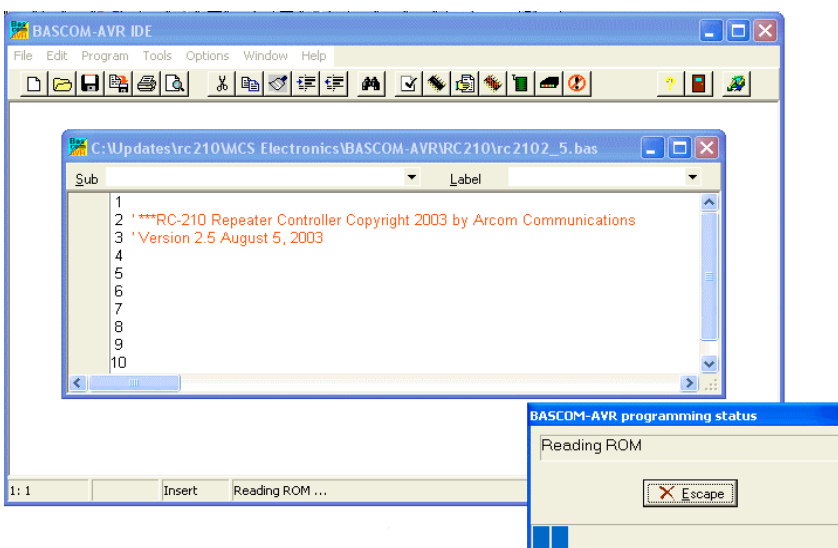

When the write cycle is over, you'll see a new window pop up. This indicates the program write is being verified as ok. Once this is done, the window should close. If you have no errors, your RC-210 should automatically reset and announce its sign-on message. Replace jumpers JP15 and JP16. You are now ready to go with the updated firmware!

If You Are Running Windows® XP

Windows XP® is different from some other operating systems in that it constantly polls the hardware in your computer. While this doesn't usually cause any problems with peripherals normally connected to your computer, it can cause corruption of the upload to your RC-210. This doesn't damage anything but it does prevent your RC-210 from being properly programmed. Fortunately, there is an easy fix for this situation. All you need do is change a setting in your Windows® registry file. Don't worry, we've made this very easy for you to do by providing a file that will automatically make the required change, on our website:

<http://www.ah6le.net/arcom/parport.zip>

Once you have it, unzip the file and double click on the file within and your registry will be updated. Reboot your computer and you should be good to go!

Note: This will not affect the operation of your printer nor anything else within your computer.

Another thing you should check is the setting of the printer port, which is normally done in your computer's BIOS setup screen. You want to make sure your printer port (LPT1 if you're your computer only has one port to begin with) is set to "EPP". If it isn't, change it (this won't affect other devices that connect to the printer port. As a matter fact, it will speed them up!) . Save the new setting and reboot your computer.

You are now ready to reprogram your RC-210!

Appendix A

Frequency Agile Radios Supported (Firmware Version 4.1)

Kenwood - All model radios with a computer port to allow control of radio.

Kenwood - mobiles such as TM-V7A, TM-G707 and handhelds, such as TH-F6A, TH-G71

Elecraft = All models with a computer port

Yaesu - FT-817, FT-847, FT100D

Icom - IC706MKIlg, IC-746

Doug Hall RBI-1 Remote Base Radio Interface

Factory Default Programming Values

When you first receive your RC-210, the following values are programmed as default:

Port Specific

Carrier/PL Access	Carrier squelch All Ports
Hang time	Port 1 - 5 seconds. Ports 2 & 3 - 3 seconds
Timeout	180 seconds All Ports
Cw Tone	Port 1 - 600 hz. Ports 2 & 3 - 800 hz
CW Speed	20 wpm All Ports
Monitor Mix	Yes All Ports
Port Enabled	Yes All Ports
Intertie to other ports	OFF All Ports
Full / Half Duplex	Port 1 - Full duplex, Ports 2 & 3 - Half duplex
Port Enabled	Yes All Ports
Receiver Enabled	Yes All Ports
DTMF Covertone	ON All Ports
Courtesy Tone	# 1 All Ports
DTMF Mute	ON All Ports
Speech Override	ON All Ports
Speech ID Override	ON All Ports
ID Aborts	ON All Ports
Control Receiver	OFF

Global

Logic Output 1 - 7	Open
Alarm 1 - 5	Disabled
Auxiliary Audio Inputs	OFF
Analog Meter Inputs	None defined
Macros	None programmed
Macro Recall Codes	10901 - 10909
Remote Base Type	Non-DTMF Kenwood (serial port type)
Remote DTMF Port	3
Fan Turn Off Time	5 minutes
Remote Base Prefix	A7
Lock Code	#
DTMF Terminator	D
Say Year	ON
RTC Correction Factor	None

Appendix B

CTCSS Codes

Kenwood (not a typo. There is no "02" Code)

Yaesu

#	Freq	#	Freq	#	Freq	#	Freq	#	Freq	#	Freq	#	Freq	#	Freq
01	67.0	12	97.4	22	136.5	32	192.8	01	67.0	11	114.8	21	162.2	31	233.6
03	71.9	13	100.0	23	141.3	33	203.5	02	71.9	12	118.8	22	167.9	32	241.8
04	74.4	14	103.5	24	146.2	34	210.7	03	77.0	13	123.0	23	173.8	33	250.3
05	77.0	15	107.2	25	151.4	35	218.1	04	82.5	14	127.3	24	179.9		
06	79.7	16	110.9	26	156.7	36	225.7	05	88.5	15	131.8	25	186.2		
07	82.5	17	114.8	27	162.2	37	233.6	06	94.8	16	136.5	26	192.8		
08	85.4	18	118.8	28	167.9	38	241.8	07	100.0	17	141.3	27	203.5		
09	88.5	19	123.0	29	173.8	39	250.3	08	103.5	18	146.2	28	210.7		
10	91.5	20	127.3	30	179.9			09	107.2	19	151.4	29	218.1		
11	94.8	21	131.8	31	186.2			10	110.9	20	156.7	30	225.7		

Icom (note: not all Icom radios support remote CTCSS selection. Check your operating manual)

00	67.0	13	103.5	26	159.8	39	199.5
01	69.3	14	107.2	27	162.2	40	203.5
02	71.9	15	110.9	28	165.5	41	206.5
03	74.4	16	114.8	29	167.9	42	210.7
04	77.0	17	118.8	30	171.3	43	218.1
05	79.7	18	123.0	31	173.8	44	225.7
06	82.5	19	127.3	32	177.3	45	229.1
07	85.4	20	131.8	33	179.9	46	233.6
08	88.5	21	136.5	34	183.5	47	241.8
09	91.5	22	141.3	35	186.2	48	250.3
10	94.8	23	146.2	36	189.9	49	254.1
11	97.4	24	151.5	37	192.8		
12	100.0	25	156.7	38	196.6		

Appendix C

Default Factory Command Codes

These are the "Factory default" codes when the RC-210 is unlocked:

15281	Port 1 Unlock	2160	Port 2 DTMF Disable	3300	Port 3 To Port 1 Off
25281	Port 2 Unlock	3160	Port 3 DTMF Disable	3301	Port 3 To Port 1 On
35281	Port 3 Unlock	1161	Port 1 DTMF Enable	3310	Port 3 To Port 2 Off
1100	Port 1 Receiver Disable	2161	Port 2 DTMF Enable	3311	Port 3 To Port 2 On
2100	Port 2 Receiver Disable	3161	Port 3 DTMF Enable	1400x	Read Meter
3100	Port 3 Receiver Disable	1170	Port 1 no PL for DTMF	1500x	Reset Meter
1101	Port 1 Receiver Enable	2170	Port 2 no PL for DTMF	1600x	Meter Alarm ON/OFF
2101	Port 2 Receiver Enable	3170	Port 3 no PL for DTMF	1700	Say Time
3101	Port 3 Receiver Enable	1171	Port 1 PL for DTMF	1701	Say Date
1110	Port 1 Transmitter Disable	2171	Port 2 PL for DTMF	181yx	UF1(y) to UF7(y)
2110	Port 2 Transmitter Disable	3171	Port 3 PL for DTMF	180	UF Extended
3110	Port 3 Transmitter Disable	1180	Port 1 Speech ID Over Off	2400	ID Abort OFF
1111	Port 1 Transmitter Enable	2180	Port 2 Speech ID Over Off	2401	ID Abort ON
2111	Port 2 Transmitter Enable	3180	Port 3 Speech ID Over Off	A71	Remote Base Frequency
3111	Port 3 Transmitter Enable	1181	Port 1 Speech ID Over On	A72	Remote Base CTCSS
1120	Port 1 Carrier Access	2181	Port 2 Speech ID Over On	A73	Remote Base Mode
2120	Port 2 Carrier Access	3181	Port 3 Speech ID Over On	A74	Doug Hall User Function
3120	Port 3 Carrier Access	1190	Port 1 Monitor Mute	A75x	Memory Select
1121	Port 1 CTCSS Access	2190	Port 2 Monitor Mute	1910	Alarm 1 Off
2121	Port 2 CTCSS Access	3190	Port 3 Monitor Mute	1911	Alarm 1 On
3121	Port 3 CTCSS Access	1191	Port 1 Monitor Mix	1920	Alarm 2 Off
1130	Port 1 Covertone Off	2191	Port 2 Monitor Mix	1921	Alarm 2 On
2130	Port 2 Covertone Off	3191	Port 3 Monitor Mix	1930	Alarm 3 Off
3130	Port 3 Covertone Off	1200	Port 1 Speech Over Off	1931	Alarm 3 On
1131	Port 1 Covertone On	2200	Port 2 Speech Over Off	1940	Alarm 4 Off
2131	Port 2 Covertone On	3200	Port 3 Speech Over Off	1941	Alarm 4 On
3131	Port 3 Covertone On	1201	Port 1 Speech Over On	1950	Alarm 5 Off
1134x	Port 1 CT Select	2201	Port 2 Speech Over On	1951	Alarm 5 On
2134x	Port 2 CT Select	2201	Port 3 Speech Over On	A11	Link Port 1 & Port 2
3134x	Port 3 CT Select	1210	Port 1 DTMF Mute Off	A21	Link Port 1 & Port 3
1140	Port 1 Half Duplex	2210	Port 2 DTMF Mute Off	A31	Link Port 2 & Port 3
2140	Port 2 Half Duplex	3210	Port 3 DTMF Mute Off	A41	Link All Ports
3140	Port 3 Half Duplex	1211	Port 1 DTMF Mute On	A10	UnLink Port 1 & Port 2
1141	Port 1 Full Duplex	2211	Port 2 DTMF Mute On	A20	UnLink Port 1 & Port 3
2141	Port 2 Full Duplex	3211	Port 3 DTMF Mute On	A30	UnLink Port 2 & Port 3
3141	Port 3 Full Duplex	1300	Port 1 To Port 2 Off	A40	Unlink All Ports
1150	Port 1 Kerchunk Off	1301	Port 1 To Port 2 On	1960	Aux Audio 1 Off
2150	Port 2 Kerchunk Off	1310	Port 1 To Port 2 Off	1961	Aux Audio 1 On
3150	Port 3 Kerchunk Off	1311	Port 1 To Port 3 On	1970	Aux Audio 2 Off
1151	Port 1 Kerchunk On	2300	Port 2 To Port 1 Off	1971	Aux Audio 2 On
2151	Port 2 Kerchunk On	2301	Port 2 To Port 1 On	1980	Aux Audio 3 Off
3151	Port 3 Kerchunk On	2310	Port 2 To Port 3 Off	1981	Aux Audio 3 On
1160	Port 1 DTMF Disable	2311	Port 2 To Port 3 On	2500	Control Rcvr Off
				2501	Control Rcvr On

10901 to 109090
Recall Macro 1 to 90

Programming Commands Quick Reference

<u>Code</u>	<u>What It Programs</u>	<u>What It Means</u>
*1000	Program Transmitter Hang Timer	Programs the xmtr Hang Timer for the currently unlocked Port
*1001	Program Time Out Time	Programs the Timeout Timer for the currently unlocked Port
*1002	Program Initial ID Period	Programs the Initial ID Timer for the currently unlocked Port
*1003	Program Pending ID Period	Programs the Pending ID Timer for the currently unlocked Port
*1004	Program Fan Time	Programs the length of time the Fan will remain on after xmtr drop
*1005	Program Port Activity Timer	Programs the Link Inactivity Timer for the currently unlocked Port
*1006	Program DTMF Mute Timer	Programs the DTMF Mute Timer for the currently unlocked Port
*1007	Program CTCSS Encode Timer	Programs the CTCSS Encode Timer for the currently unlocked Port
*1008	Program Alarm 1 Time Out Timer	Programs how long Alarm 1 remains active after triggering
*1009	Program Alarm 2 Time Out Timer	Programs how long Alarm 2 remains active after triggering
*1010	Program Alarm 3 Time Out Timer	Programs how long Alarm 3 remains active after triggering
*1011	Program Alarm 4 Time Out Timer	Programs how long Alarm 4 remains active after triggering
*1012	Program Alarm 5 Time Out Timer	Programs how long Alarm 5 remains active after triggering
*1013	Program Aux Audio 1 Time Out Timer	Programs how long Aux Audio 1 remains ON
*1014	Program Aux Audio 2 Time Out Timer	Programs how long Aux Audio 2 remains ON
*1015	Program Aux Audio 3 Time Out Timer	Programs how long Aux Audio 3 remains ON
*1017	Program Alarm Debounce Period	Programs how long the Debounce time should be
*1018	Program the Kerchunk Filter Delay Period	Programs the Kerchunk filtering time on the currently unlocked Port
*1019	Set Pending ID Speak Timer	Controls how Pending ID Voice/CW IDs are processed
*1020	Set Announce Timer	Sets how long the Announce Message will play after repeater activity stops
*2050xx	Program Command Macro Recall Code	Programs the code used to recall remapped Command Macros
*2060	Program Remote Base Prefix	Programs the Prefix prepended to default Remote Base commands
*2064	Program A/D Channel	Programs the channel and meter face
*2065	Program Vref	Programs the voltage reference used for A/D measurements
*2066	Program Meter Alarm	Programs the high and low trippoints for the Meter Alarms
*2083	Set Radio Type	Select which type of radio is used as a Remote Base
*2084	Set Yaesu Type	If Yaesu is selected, select which type format to use
*2085	Store Remote Base Memory	Store Remote Base frequency, CTCSS and offset in non-volatile memory
*2100	Set Aux Audio Port Routing	Set the port(s) to which the Aux audio should be sent
*2101	Program Aux Audio for Alarms	Selects (if any) Aux Audio inputs for use in Alarms
*2102	Program Alarm Macro	Program which Macro an Alarm should use
*2103	Program Message Macros	Program the messages using in Message Macros
*2104	Program Command Prefix	Programs the prefix to use before any default command
*2105	Program DTMF Memory	Programs the DMTF sequence to be sent
*2106	Program Send DTMF Duration	Programs the duration of transmitted DTMF digits
*2107	Program DTMF Pause Time	Programs the period between transmitted DTMF digits
*2110x	Program Tail Message	Programs a Tail Message for the currently unlocked Port
*2111x	Select Tail Message	Selects Tail Message 1, 2 or 3 for the currently unlocked Port (0 turns off)
*2112x	Select Tail Counter	Sets the Tail Message Counter (0 to 254) 0 turns the counter OFF
*21999	Reset Controller	Reset the controller
*31CTx	Program Courtesy Tone Segment 1	Program Courtesy Tone x Segment 1
*32CTx	Program Courtesy Tone Segment 2	Program Courtesy Tone x Segment 2
*33CTx	Program Courtesy Tone Segment 3	Program Courtesy Tone x Segment 3
*34CTx	Program Courtesy Tone Segment 4	Program Courtesy Tone x Segment 4
*4001	Program Scheduler	Program the Scheduler to run automated events
*4002	Program A Macro	Program a series of functions into one macro command or remap
*4003	Erase A Specific Command Macro	Erase a previously stored Command Macro by Macro Number
*400499	Erase All Command Macros	Erase ALL Command Macros
*4005	Program Command Macro Port Restrictions	Select which Ports a Command Macro can be called from
*400699	Erase All Command Macro Port Restrictions	Allows all Command Macros to be called from all Ports
*400799	Clear All Setpoints	Erases all programmed Scheduler Setpoints
*5100	Set Time	Sets the Real Time Clock
*5101	Set Date	Sets the Calendar
*5102x	Say/Don't say year as part of date	Enables/disables readback of the year when the date is spoken
*5105x	Bump Clock Seconds	Adds or subtracts x seconds from clock time (to allow "fine tuning")
*7001x	Record DVR Message	Record a DVR Track x = Track 1 to 20
*7002x	Erase DVR Message	Erase a DVR Track x = Track 1 to 20
*700399	Erase ALL DVR Messages	Erases all DVR Tracks 1 to 20
*7004x	Remove last segment of DVR Message	Remove the last 200 ms. of Track 1 to 20
*7005x	Replace last segment of DVR Message	Replace the last 200 ms. of Track 1 to 20
*70060	Recall Seconds Left	Tells you the remaining recording time available
*8000	Program CW Speed	Programs CW Speed of the currently unlocked Port
*8001	Program CW Tone	Programs the CW Tone(s) frequency of the currently unlocked Port
*8002	Program CW ID 1	Programs the CW Message used for CW ID 1
*8003	Program CW ID 2	Programs the CW Message used for CW ID 2
*8004	Program Voice ID 1	Programs the message used for Voice ID 1
*8005	Program Voice ID 2	Programs the message used for Voice ID 2
*8006	Program Voice ID 3	Programs the message used for Voice ID 3
*8007	Program ID Extras	Programs the Extra message for Voice IDs
*8008x	Enable Voice IDs	Enables/Disables Voice IDs: 1 = Enabled, 0 = Disabled
*9000	Program Unlock Code	Programs the Unlock Code for the currently unlocked Port
*9010xxxx	Program Lock Code	Programs the code to lock ALL ports
*9020x	Program DTMF Terminator	Programs the DTMF digit used to force command evaluation

Vocabulary List

000	ZERO	057	ACTIVE	113	FAILURE
001	ONE	058	AFTERNOON	114	FEBRUARY
002	TWO	059	ALERT	115	FEET
003	THREE	060	ALL	116	FREQUENCY
004	FOUR	061	AMATEUR	117	FRIDAY
005	FIVE	062	AMPS	118	FROM
006	SIX	063	AND	119	FULL
007	SEVEN	064	ANSWER	120	GET
008	EIGHT	065	APRIL	121	GO
009	NINE	066	ASSOCIATION	122	GOOD
010	TEN	067	AT	123	HAM
011	ELEVEN	068	AUGUST	124	HELLO
012	TWELVE	069	AUTO	125	HELP
013	THIRTEEN	070	AUTOMATIC	126	HERTZ
014	FOURTEEN	071	AUXILARY	127	HIGH
015	FIFTEEN	072	AVERAGE	128	HOLD
016	SIXTEEN	073	A.M.	129	HOUR
017	SEVENTEEN	074	BAND	130	INTERNET
018	EIGHTEEN	075	BASE	131	INTRUDER
019	NINETEEN	076	BATTERY	132	IS
020	TWENTY	077	BELOW	133	JANUARY
021	THIRTY	078	BUSY	134	JULY
022	FOURTY	079	BY	135	JUNE
023	FIFTY	080	CALIBRATE	136	LEFT
024	SIXTY	081	CALL	137	LIGHT
025	SEVENTY	082	CANCEL	138	LINE
026	EIGHTY	083	CARRIER	139	LINK
027	NINETY	084	CAUTION	140	LOCK
028	HUNDRED	085	CHANGE	141	LOW
029	THOUSAND	086	CHECK	142	MANUAL
030	A	087	CLEAR	143	MARCH
031	B	088	CLOCK	144	MAXIMUM
032	C	089	CODE	145	MAY
033	D	090	COMPLETE	146	MEETING
034	E	091	COMPUTER	147	MEGA
035	F	092	CONNECT	148	MESSAGES
036	G	093	CONNECTED	149	METER
037	H	094	CONTROL	150	MILES PER HOUR
038	I	095	CONTROLLER	151	MINIMUM
039	J	096	CURRENT	152	MINUS
040	K	097	DANGER	153	MINUTES
041	L	098	DATE	154	MIX
042	M	099	DAY	155	MONDAY
043	N	100	DECEMBER	156	MONITOR
044	O	101	DEGREES	157	MORNING
045	P	102	DEVIATION	158	MUTE
046	Q	103	DIRECTION	159	NEGATIVE
047	R	104	DISCONNECTED	160	NET
048	S	105	DOWN	161	NIGHT
049	T	106	EAST	162	NO
050	U	107	ECHO	163	NORTH
051	V	108	EMERGENCY	164	NOT
052	W	109	ENTER	165	NOVEMBER
053	X	110	EQUAL	166	NUMBER
054	Y	111	ERROR	167	OCLOCK
055	Z	112	EVENING	168	OCTOBER
056	ABOVE			169	OF

170	OFF	227	WATTS
171	ON	228	WEATHER
172	OPERATOR	229	WEDNESDAY
173	OUT	230	WELCOME
174	OVER	231	WEST
175	PATCH	232	YESTERDAY
176	PERCENT	233	ZULU
177	PHONE	234	S (makes plural)
178	PLEASE	235	SILENCE (pause)
179	PLUS		
180	POINT	236	DVR TRACK 1
181	PORT	237	DVR TRACK 2
182	POWER	238	DVR TRACK 3
183	PROGRAM	239	DVR TRACK 4
184	P.M.	240	DVR TRACK 5
185	RADIO	241	DVR TRACK 6
186	READY	242	DVR TRACK 7
187	RECEIVE	243	DVR TRACK 8
188	REMOTE	244	DVR TRACK 9
189	REPEAT	245	DVR TRACK 10
190	REPEATER	246	DVR TRACK 11
191	SATURDAY	247	DVR TRACK 12
192	SECONDS	248	DVR TRACK 13
193	SELECT	249	DVR TRACK 14
194	SEPTEMBER	250	DVR TRACK 15
195	SET	251	DVR TRACK 16
196	SKYWARN	252	DVR TRACK 17
197	SOUTH	253	DVR TRACK 18
198	SQUELCH	254	DVR TRACK 19
199	START	255	DVR TRACK 20
200	STOP		
201	SUNDAY		
202	SYSTEM		
203	TEMPERATURE		
204	THANK YOU		
205	THE (long)		
206	THE (short)		
207	THE TIME IS		
208	THIS		
209	THURSDAY		
210	TIME		
211	TIMEOUT		
212	TIMER		
213	TODAY		
214	TOMORROW		
215	TO NE		
216	TONIGHT		
217	TRANSMIT		
218	TUESDAY		
219	UNDER		
220	UP		
221	USE (noun)		
222	USE (verb)		
223	VOLTAGE		
224	VOLTS		
225	WAIT		
226	WARNING		

Audio Spectrum Analyzer Software From InterFlex Systems

If you have an interest in obtaining a Real Time Audio Spectrum Analysis software package that uses your sound card to make measurements of audio amplitude, spectrum analysis, frequency response information, and can generate tones, white noise, pink noise, sweep tests, etc., Arcom Communications has arranged with InterFlex Systems Design Corporation of California to make their software available to owners of any ARCOM product, either the RC110 or RC210. You can view some details about the program at <http://www.interflex.com/arcom/> . Purchase information is available on that webpage.

The RC-210 Development And Testing Team

Programmers:

Ken Arck, AH6LE (formerly WA6EMV), CTO Arcom Communications
Jeffrey G. Towle, Ph.D., W6FCC (formerly WA4EGT), InterFlex Systems Design Corp

Testers:

Danny Hampton K4ITL
Terry Bartholomew NQ4Y
Les Fenison KD7RY
Kris Schatz KR7IS

ARCOM COMMUNICATIONS NO-NONSENSE LICENSE AGREEMENT FOR THE OPERATING FIRMWARE OF THE RC-210 REPEATER CONTROLLER

IMPORTANT - READ CAREFULLY

This license statement and limited warranty constitutes a legal agreement ("License Agreement") between you (either as an individual or a single entity) and Arcom Communications for the software product ("Firmware") identified above, including any software, media, and accompanying on-line or printed documentation.

BY DOWNLOADING OR OTHERWISE USING THE FIRMWARE, YOU AGREE TO BE BOUND BY ALL OF THE TERMS AND CONDITIONS OF THIS LICENSE AGREEMENT.

Upon your acceptance of the terms and conditions of the License Agreement, Arcom Communications grants you the right to use the Firmware in the manner provided below.

This Firmware is owned by Arcom Communications and is protected by copyright law and international copyright treaty. Therefore, you must treat this Firmware like any other copyrighted material (e.g., a book), except that you may either make copies of the Firmware solely for backup or archival purposes or transfer the Firmware to a single hard disk provided you keep the original solely for backup or archival purposes.

You may transfer the Firmware and documentation on a permanent basis provided you retain no copies and the recipient agrees to the terms of this License Agreement. Except as provided in this License Agreement, you may not transfer, rent, lease, lend, copy, modify, translate, sublicense, time-share or electronically transmit or receive the Firmware, media or documentation.

TO THE MAXIMUM EXTENT PERMITTED BY APPLICABLE LAW, ARCOM COMMUNICATIONS DISCLAIM ALL OTHER WARRANTIES AND CONDITIONS, EITHER EXPRESS OR IMPLIED, INCLUDING, BUT NOT LIMITED TO, IMPLIED WARRANTIES OF MERCHANTABILITY, FITNESS FOR A PARTICULAR PURPOSE, TITLE, AND NON-INFRINGEMENT, WITH REGARD TO THE FIRMWARE, AND THE PROVISION OF OR FAILURE TO PROVIDE SUPPORT SERVICES. THIS LIMITED WARRANTY GIVES YOU SPECIFIC LEGAL RIGHTS. YOU MAY HAVE OTHERS, WHICH VARY FROM STATE/JURISDICTION TO STATE/JURISDICTION.

LIMITATION OF LIABILITY TO THE MAXIMUM EXTENT PERMITTED BY APPLICABLE LAW, IN NO EVENT SHALL ARCOM COMMUNICATIONS OR ITS SUPPLIERS BE LIABLE FOR ANY SPECIAL, INCIDENTAL, INDIRECT, OR CONSEQUENTIAL DAMAGES WHATSOEVER (INCLUDING, WITHOUT LIMITATION, DAMAGES FOR LOSS OF BUSINESS PROFITS, BUSINESS INTERRUPTION, LOSS OF BUSINESS INFORMATION, OR ANY OTHER PECUNIARY LOSS) ARISING OUT OF THE USE OF THE FIRMWARE OR INABILITY TO USE THE FIRMWARE PRODUCT OR THE PROVISION OF OR FAILURE TO PROVIDE SUPPORT SERVICES, EVEN IF ARCOM COMMUNICATIONS HAS BEEN ADVISED OF THE POSSIBILITY OF SUCH DAMAGES.